

Balançoires et Téléphériques



Balançoires simples et doubles





Projets pour personnes à mobilité réduite



Projets pour personnes à mobilité réduite



Projets pour personnes à mobilité réduite





Projets pour personnes à mobilité réduite





Projets pour personnes à mobilité réduite

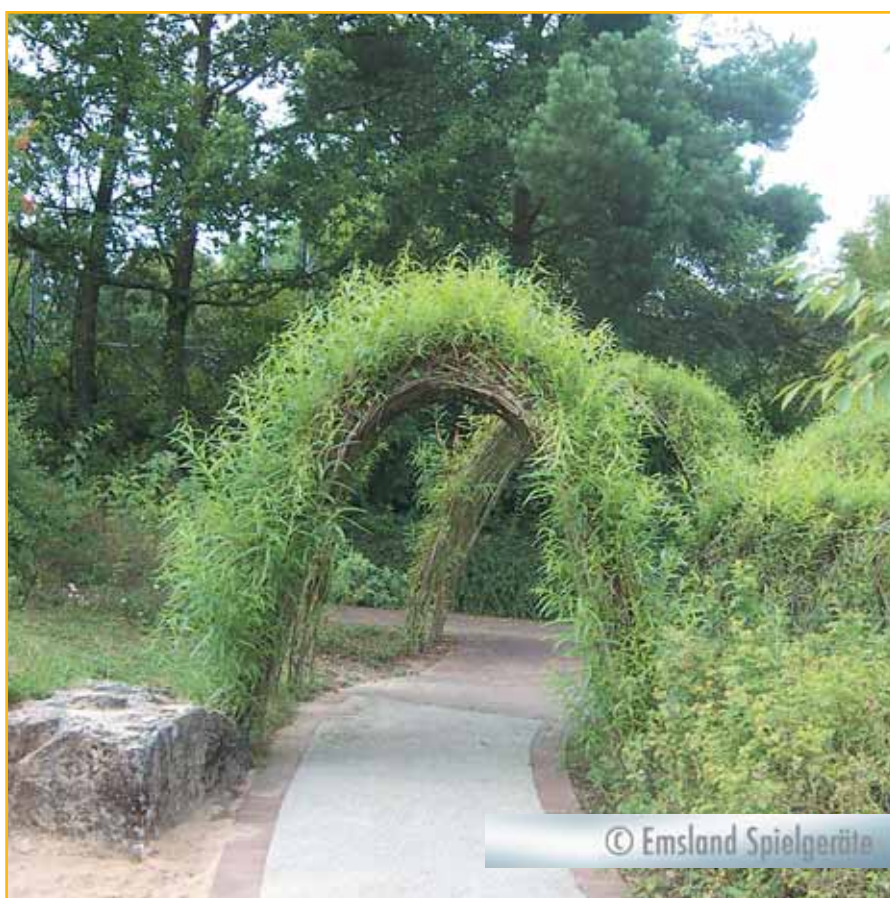

Projets pour personnes à mobilité réduite



Projets pour personnes à mobilité réduite

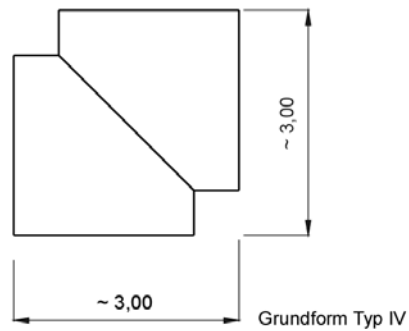
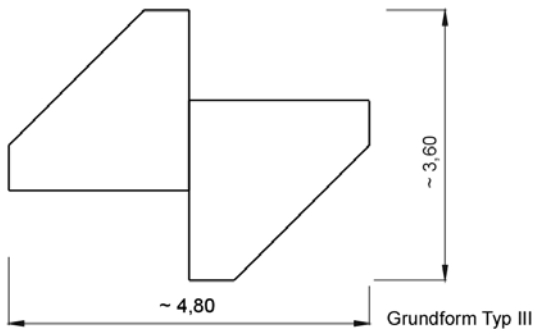
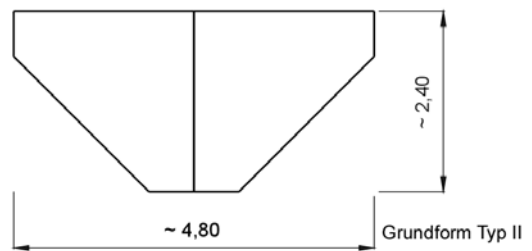
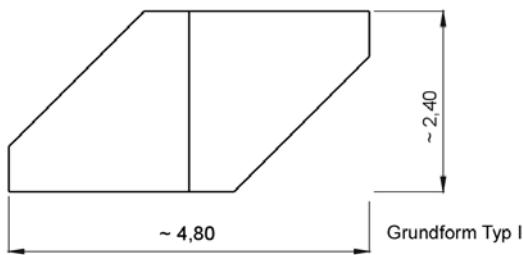
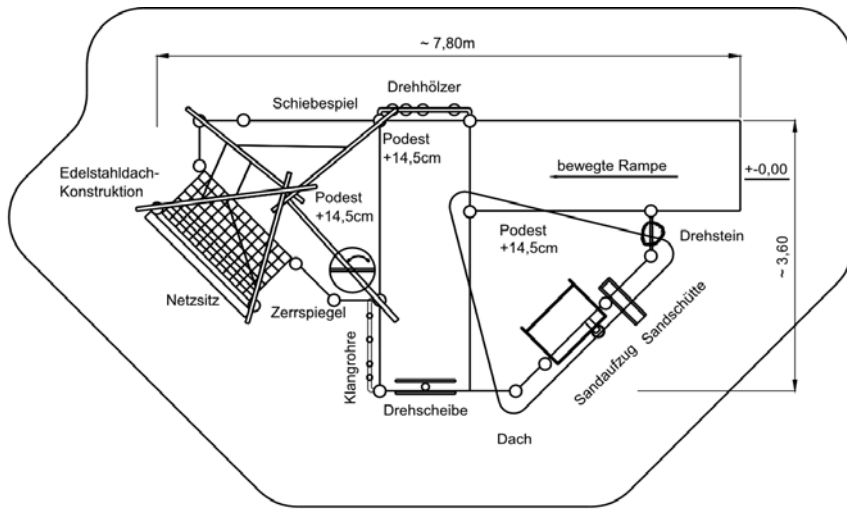

Balançoires et Téléphériques

Référence siehe Tabelle

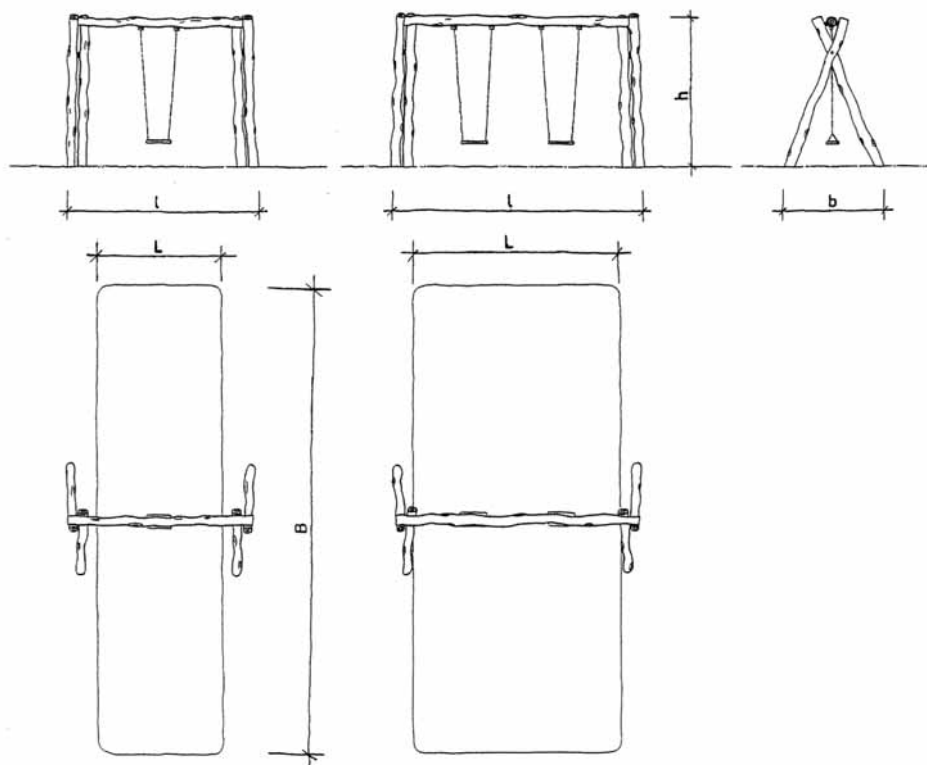

Balançoires et Téléphériques



Référence 022930

Référence 022931

Balançoires et Téléphériques

Référence 022930D, R

Référence 022931L, V, VL

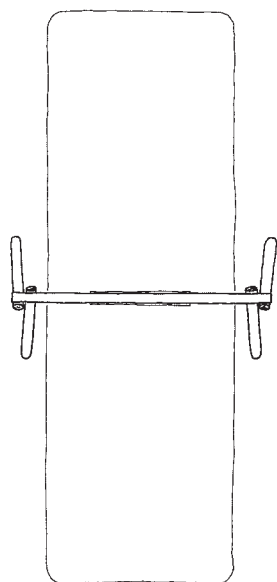
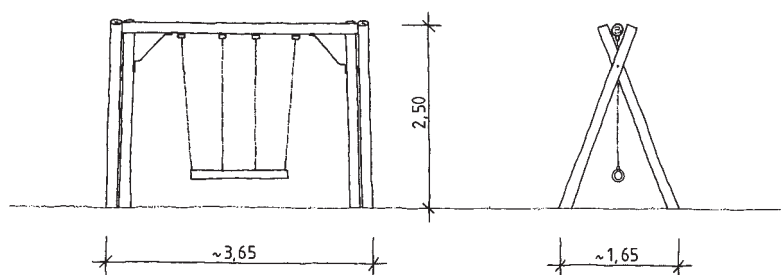

Balançoires et Téléphériques



**Balançoire Kalotta et
balançoire nid**



Balançoires et Téléphériques

Référence 022863 D, T

Référence 022864 L, V, VL

Référence 022865 R

Référence 022860 D, T

Référence 022861 L, V, VL

Référence 022862 R

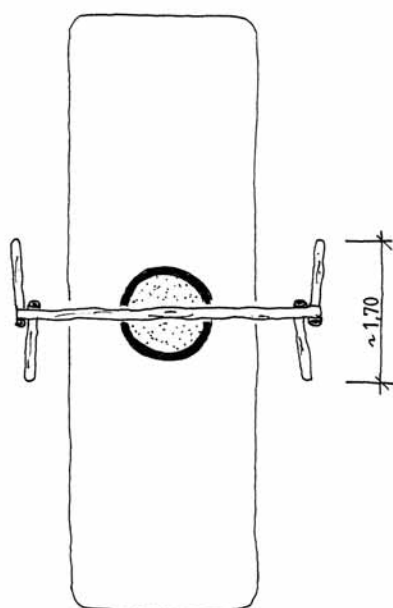
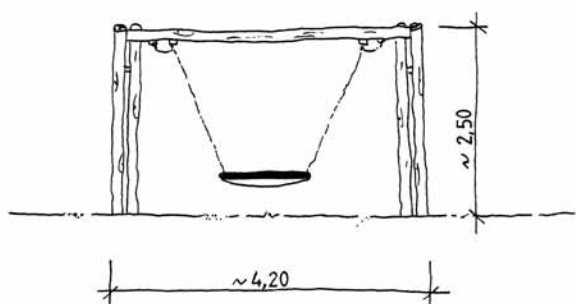

KalottaSwing 022862R

Balançoires et Téléphériques



Balançoire en acier

Référence 022840 - 43

Balançoires et Téléphériques

Référence 022840 - 43L, V, VL

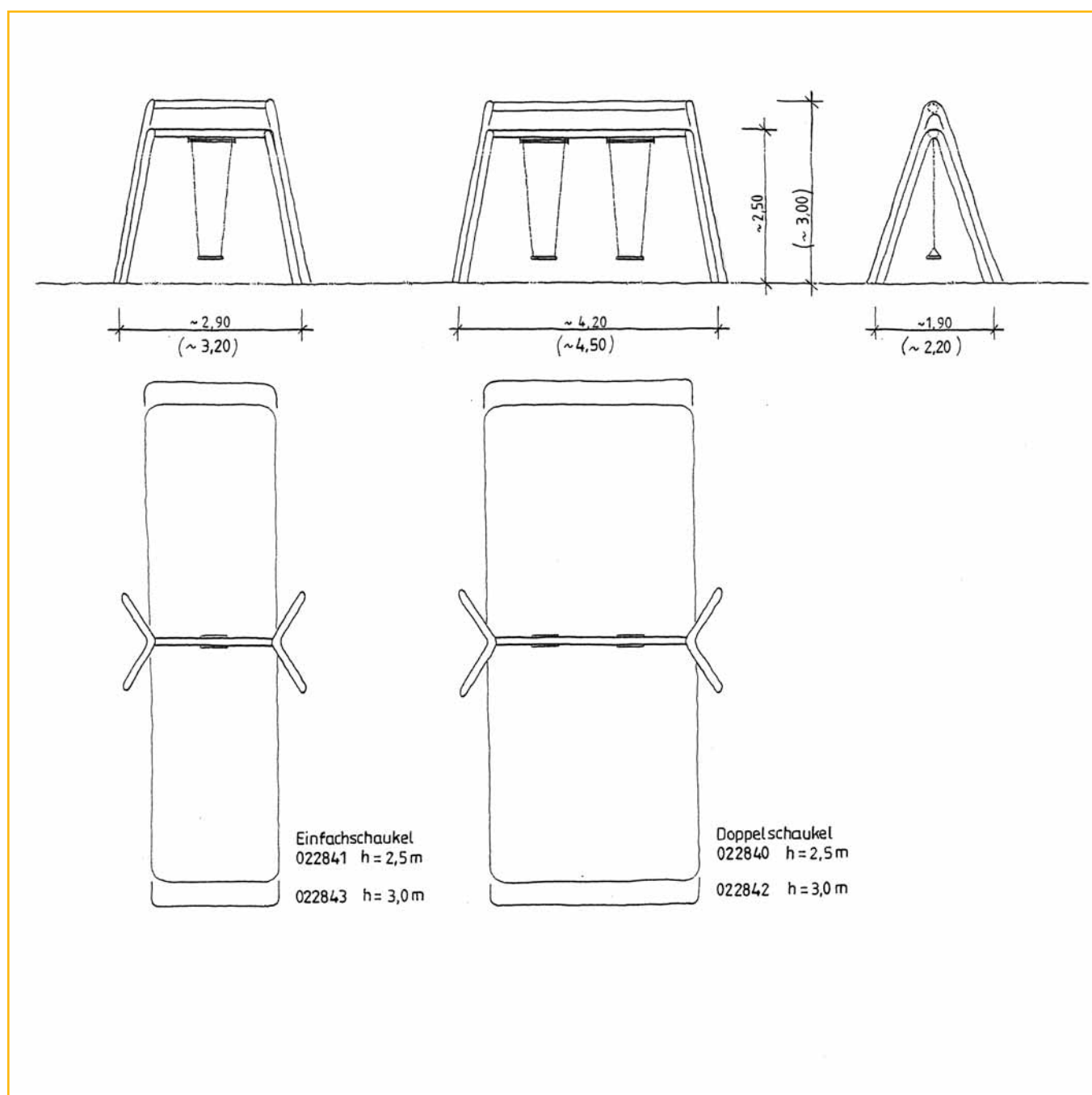

Balançoires et Téléphériques



Balançoire Partner

Balançoires et Téléphériques



Balançoires et Téléphériques



Référence 023030

Référence 023040

Balançoires et Téléphériques

Référence 023030V, VL

Référence 023040V, VL,

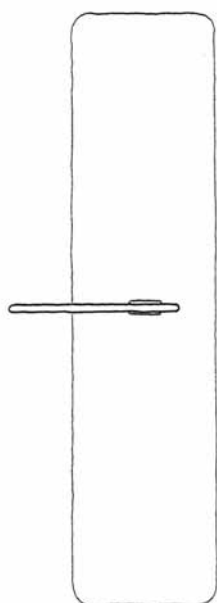
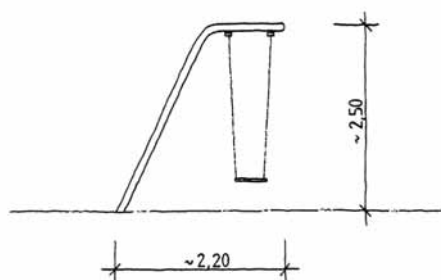

Freischwinger 023030

Balançoires et Téléphériques

Kinderland
Emsland Spielgeräte



Référence 022830

Référence 021070

Balançoires et Téléphériques

Référence 022830D, R
Artikel-Nr 021070L, V, VL

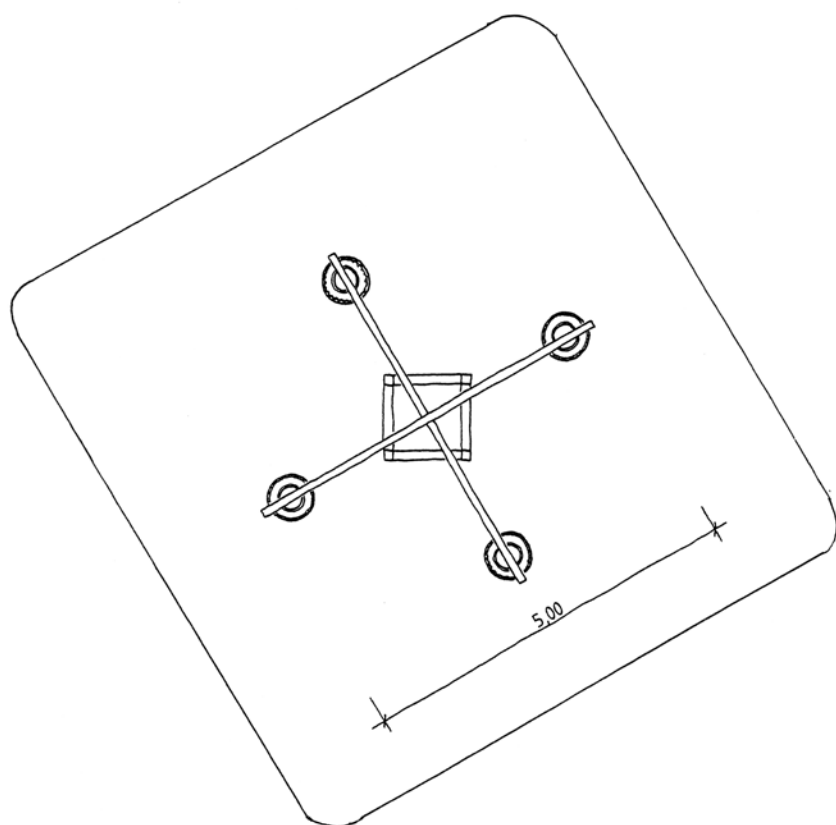
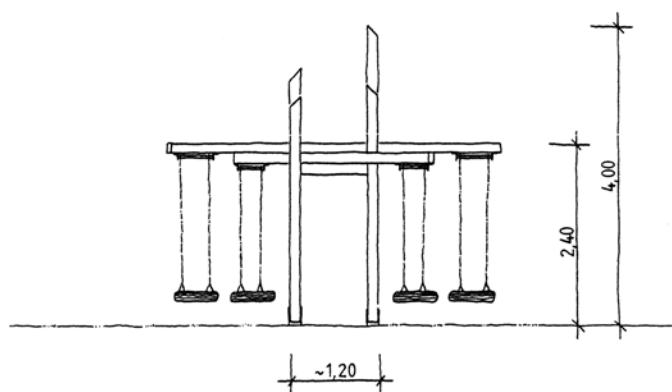

Hanseatschaukel 022830D

Balançoires et Téléphériques



Référence 022870

Référence 022871



Balançoires et Téléphériques

Référence 022870D, R

Référence 022871D, R

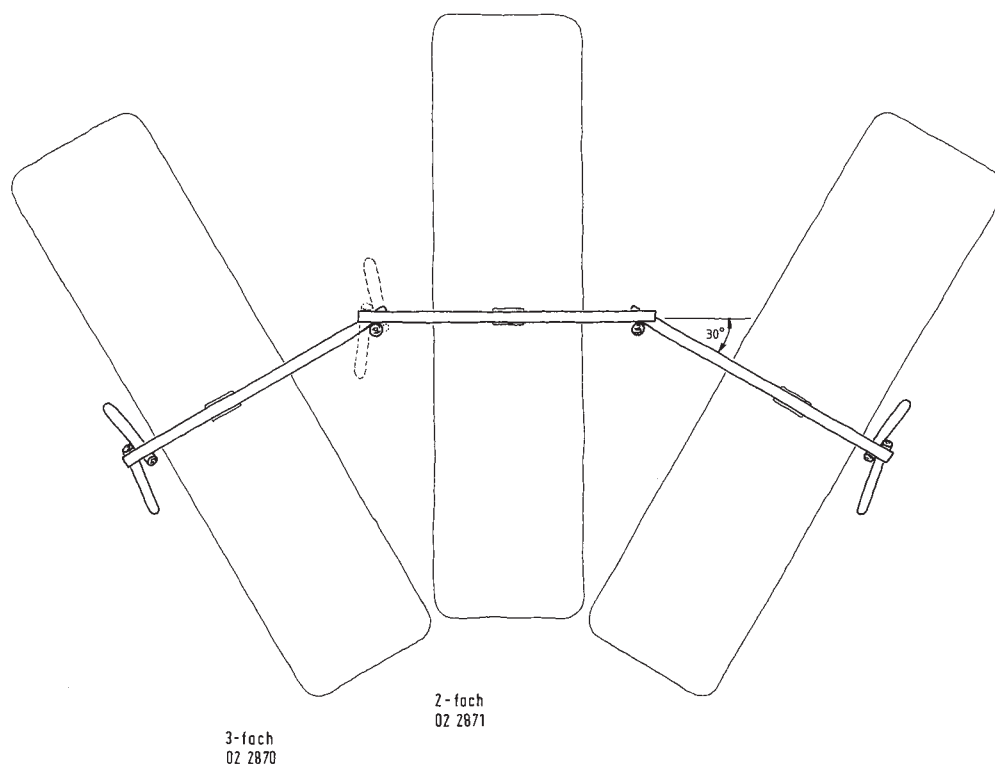
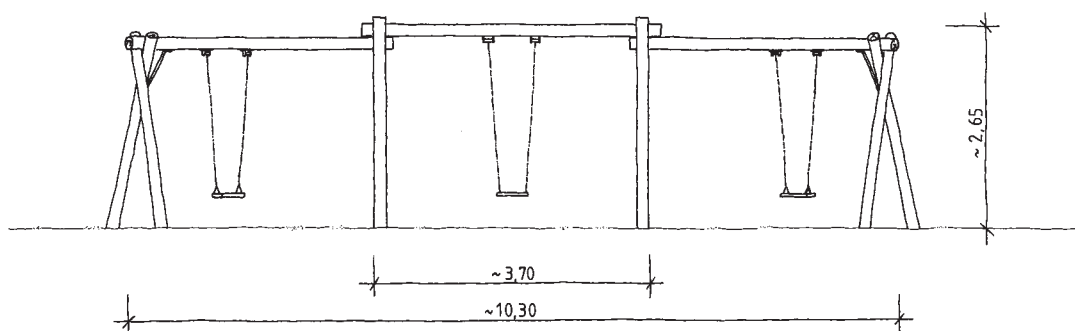

Balançoires et Téléphériques



Référence 022821

Référence 022822

Balançoires et Téléphériques

Référence 022821D, R

Référence 022822L, V, VL

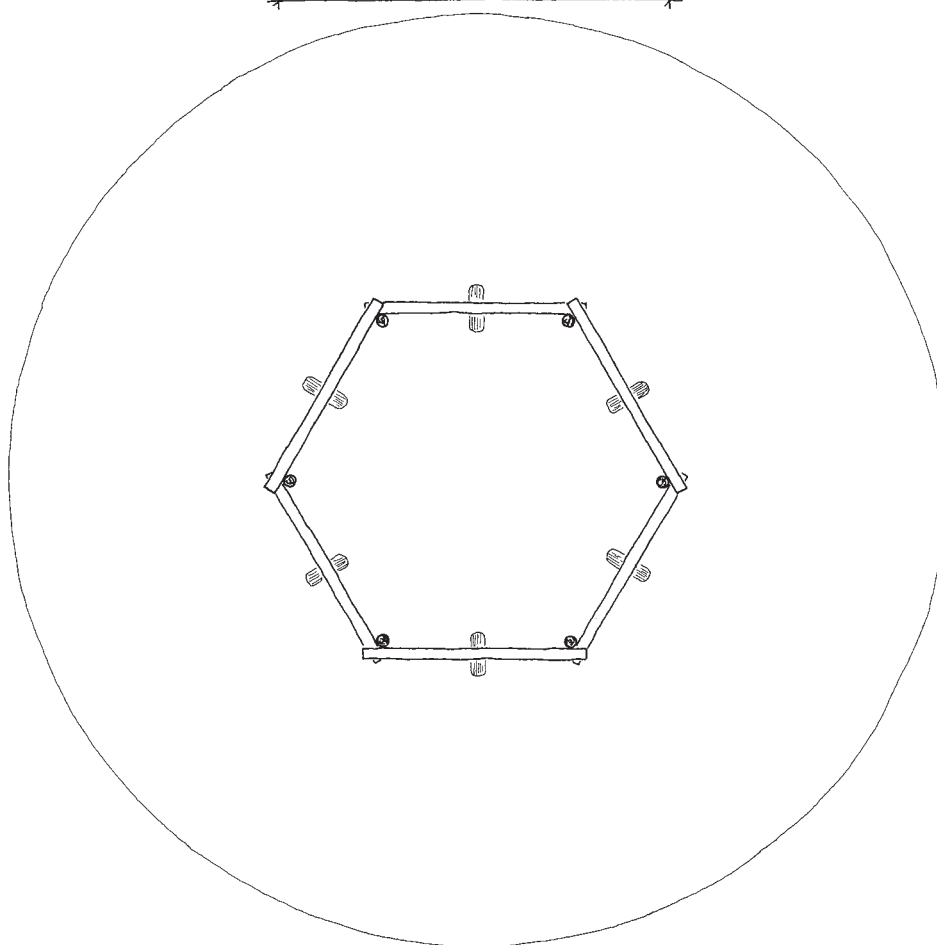
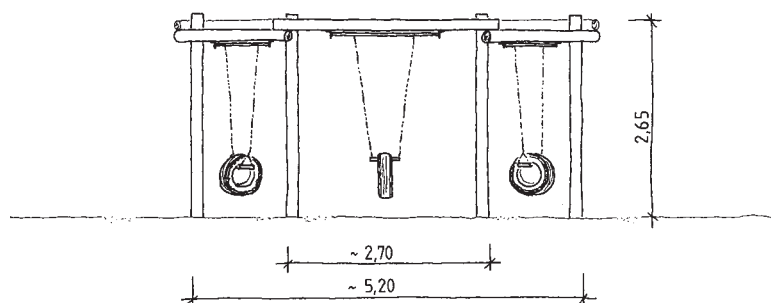

Balançoires et Téléphériques



Référence 022660/3-4
Référence 021085



Balançoires et Téléphériques

Référence 022660/3-4T, R

Référence 021085L, V, VL

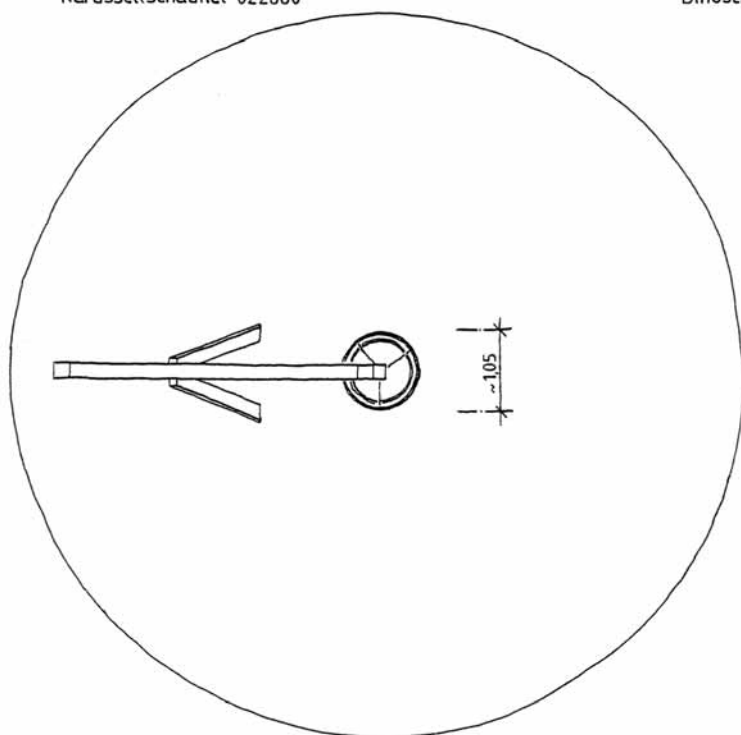
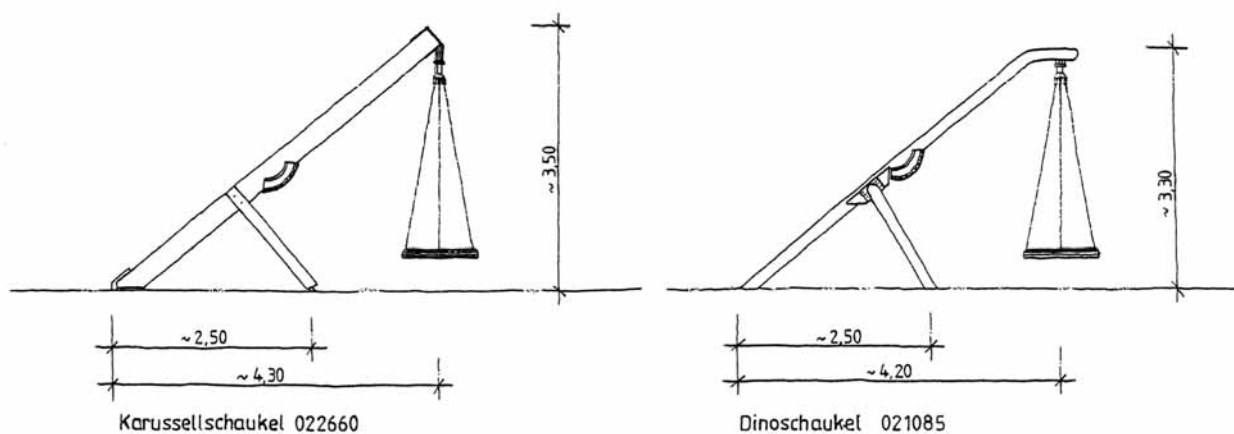

Balançoires et Téléphériques



Référence 022935

Référence 022936

Balançoires et Téléphériques

Référence 022935H, T, L, V, VL

Référence 022936H, T, L, V, VL

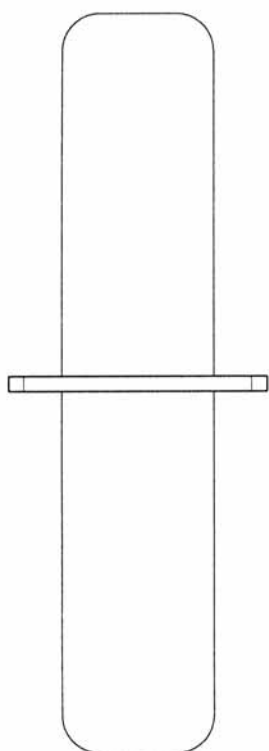
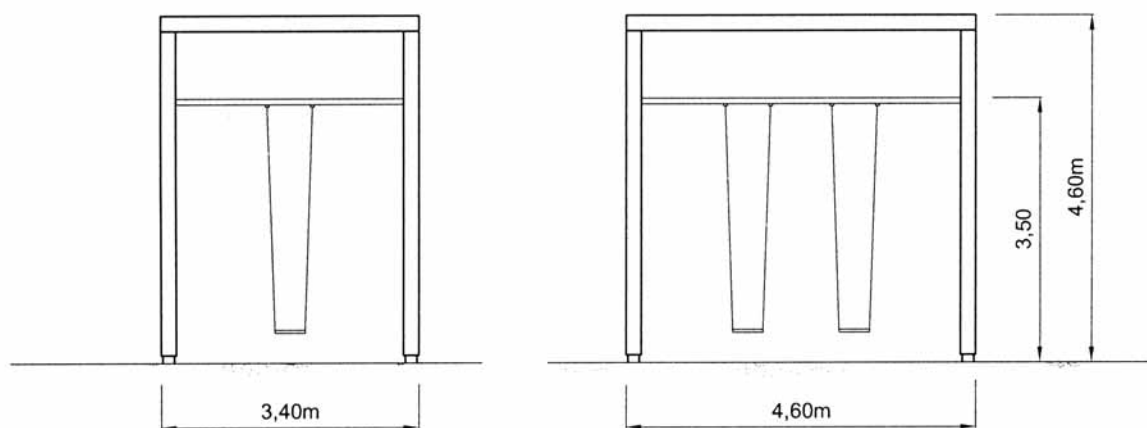

Einfachschaukel Frankfurt
022935

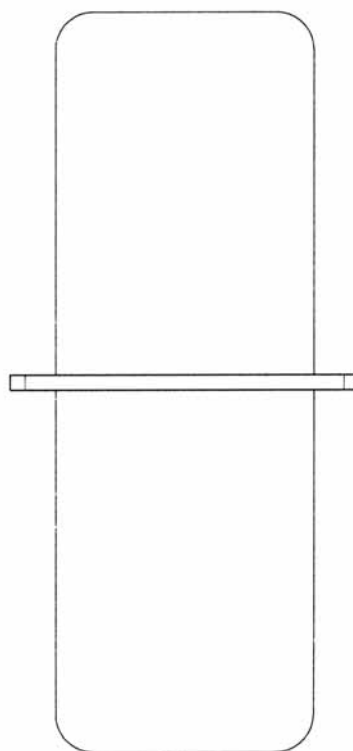

Doppelschaukel Frankfurt
022936

Balançoires et Téléphériques



Balançoire Multi



Balançoires et Téléphériques

Référence 023010D, R

Référence 023011L, V, VL

Référence 023012T

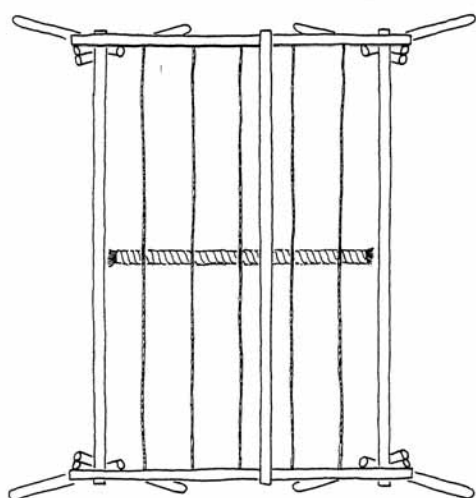
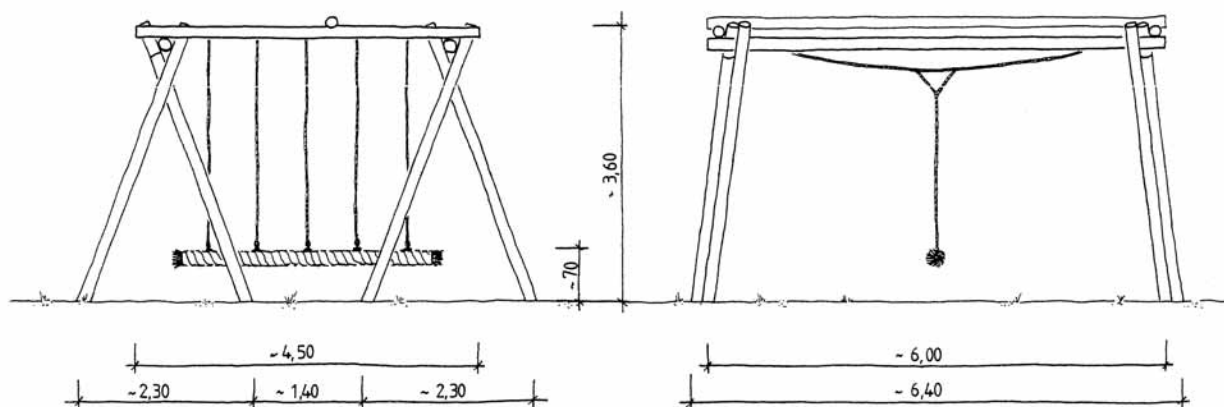

Tauschaukel 023010D

Balançoires et Téléphériques



Balançoire Nid accessible aux personnes à mobilité réduite

Référence 023020

Référence 023021



Balançoires et Téléphériques

Référence 023020D, R

Référence 023020/2D, R

Référence 023021L, V, VL

Référence 023021/2L, V, VL

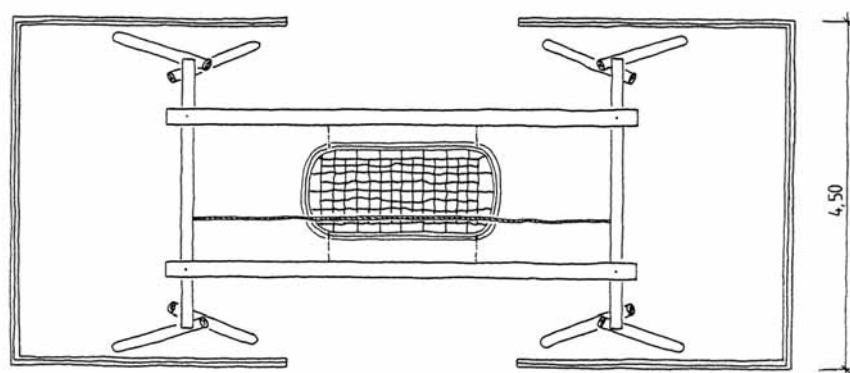
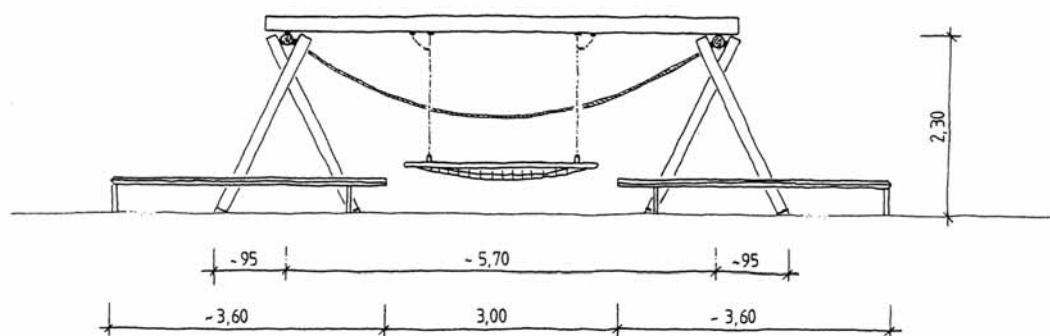

Netzschaukel 023020D

Balançoires et Téléphériques



RBalançoire accessible en fauteuil roulant

Référence 122926

Référence 122927

Balançoires et Téléphériques

Référence 122926V, VL

Référence 122927L, V, VL

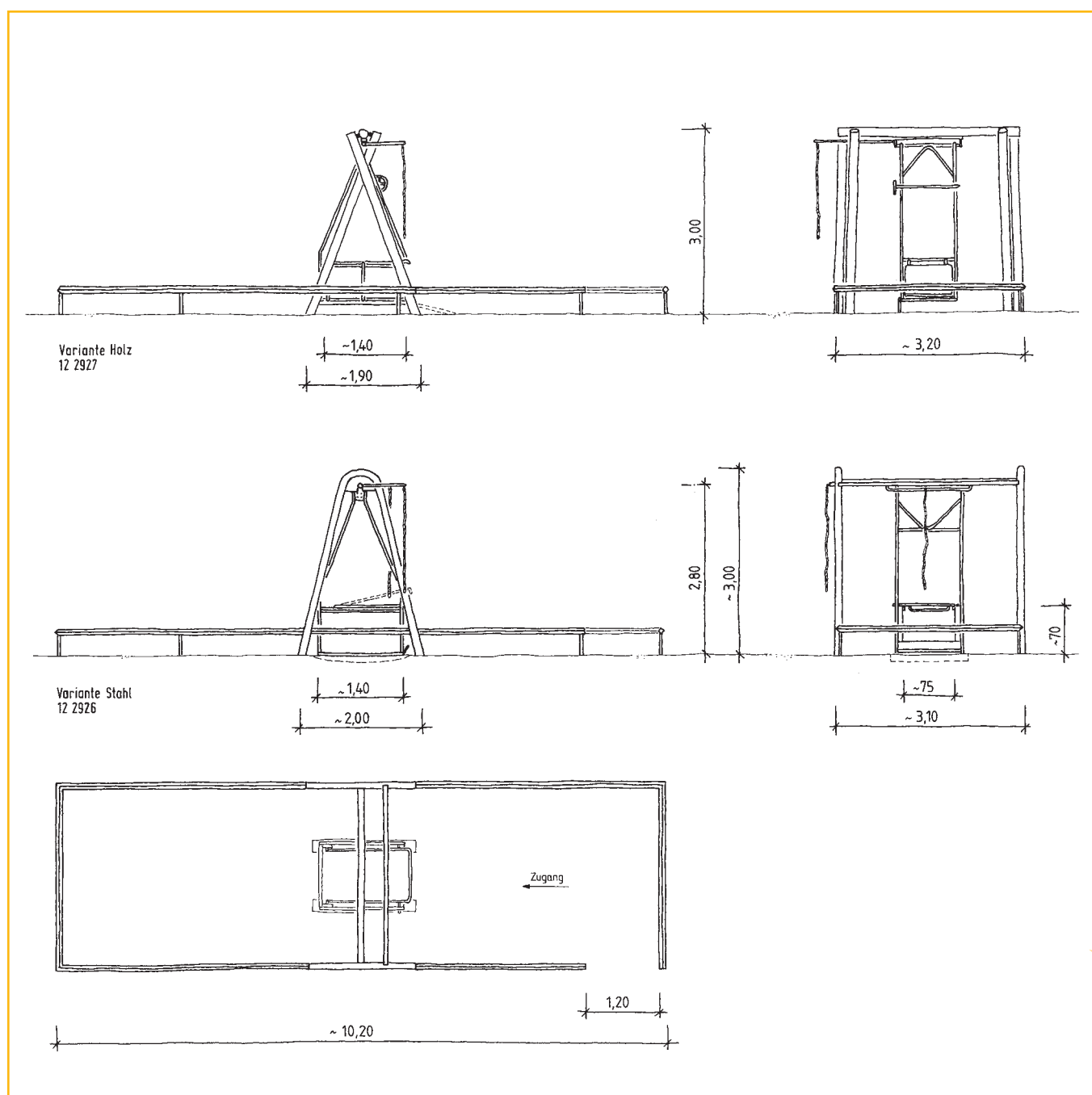

Balançoires et Téléphériques



Balançoire Tarzan

Référence 023000

Référence 023001

Balançoires et Téléphériques

Référence 023000R

Référence 023001L, V, VL

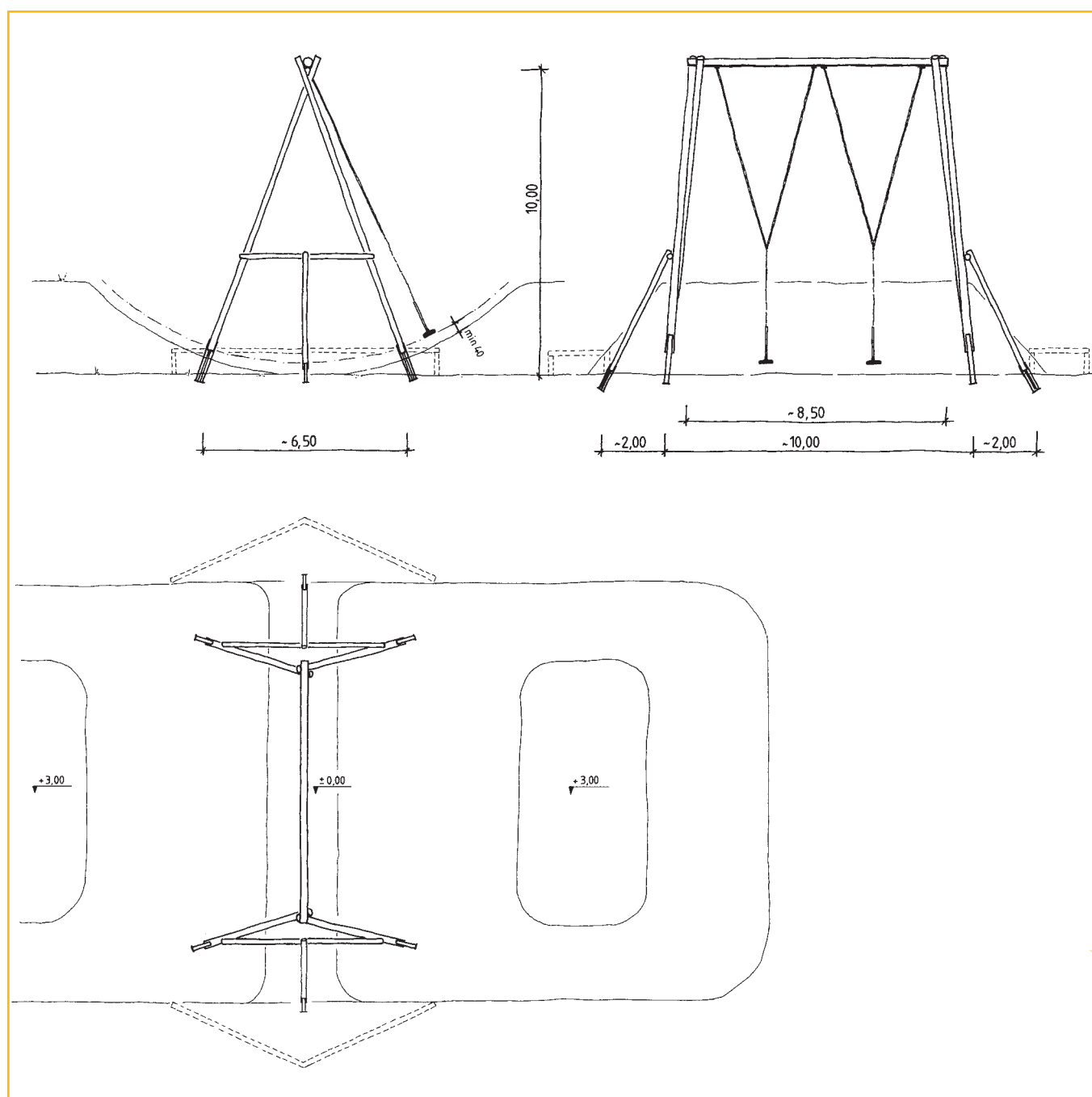

Balançoires et Téléphériques



Téléphériques

Référence 012492 - 012498



Balançoires et Téléphériques

Référence 012492D

Référence 012494V, VL

Référence 012495R

Référence 012498T

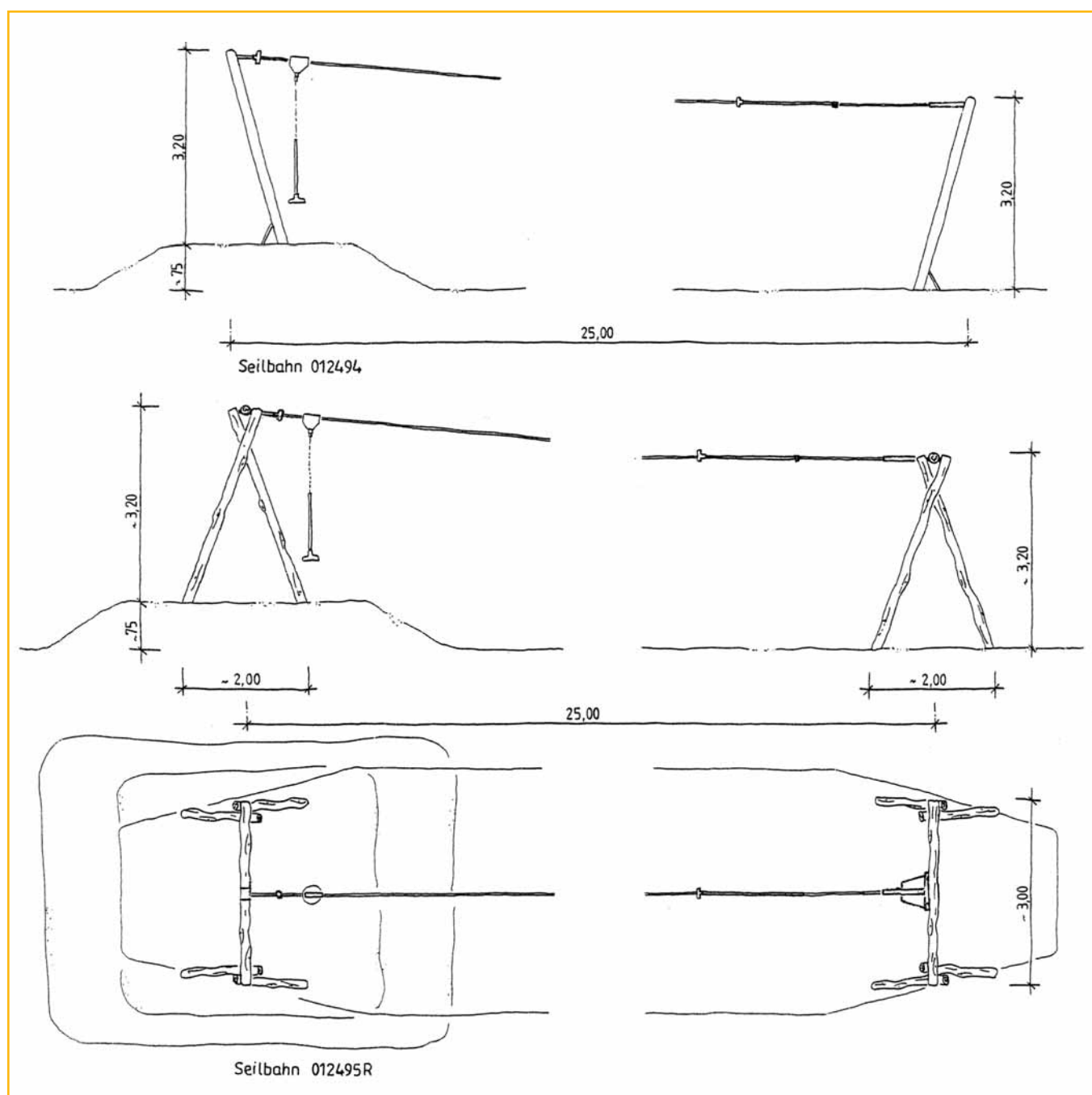

Balançoires et Téléphériques



Hamacs

Référence 022850

Référence 022851

Balançoires et Téléphériques

Référence 022850R

Référence 022851V, VL

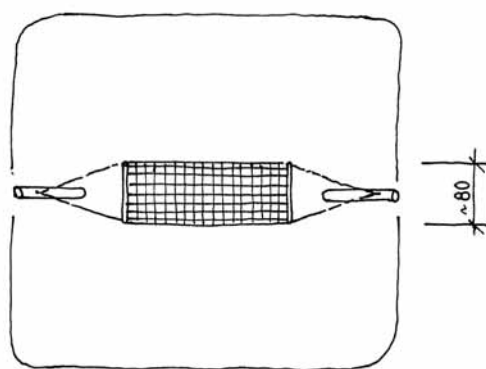
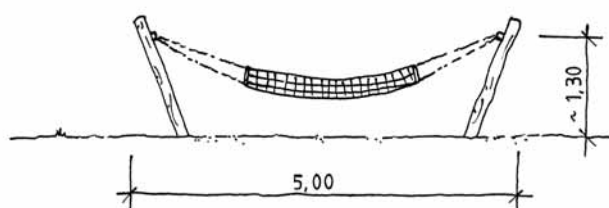

Schaukelmatte 022850R

Balançoires et Téléphériques

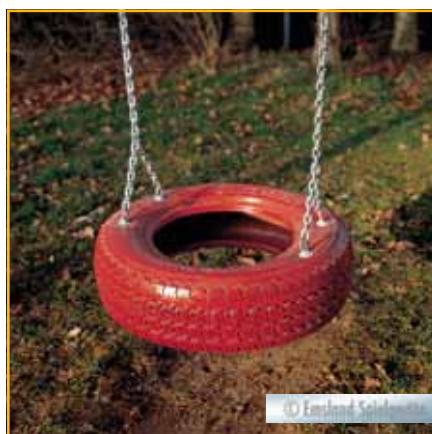

Sièges pour balançoires

Référence siehe Zeichnung

Balançoires et Téléphériques

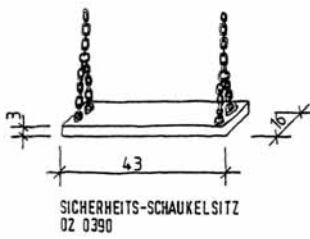

SICHERHEITS-SCHAUKELSTZ
02 0390

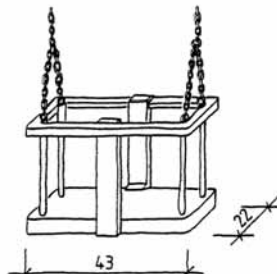

SICHERHEITS-SCHAUKELSTZ
02 0386

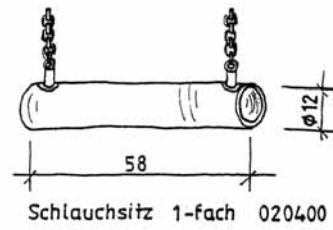

Schlauchsitz 1-fach 020400

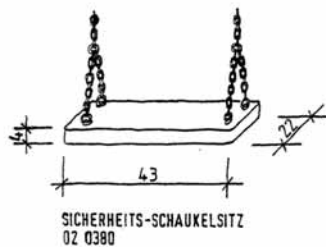

SICHERHEITS-SCHAUKELSTZ
02 0380

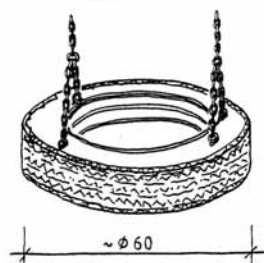

SCHAUKELREIFEN
02 0385

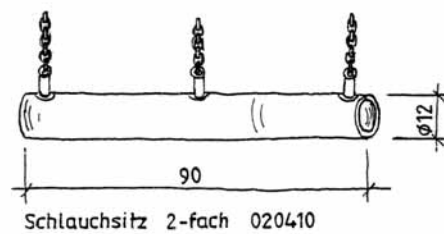

Schlauchsitz 2-fach 020410

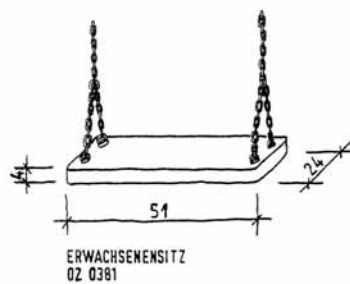

ERWACHSENENSITZ
02 0381

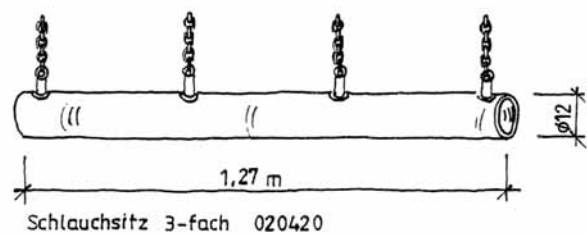

Schlauchsitz 3-fach 020420

Aménagements d'aires de jeux



Aménagements d'aires de jeux





Zoo de Rotterdam



Aménagements d'aires de jeux





Kinderland
Emsländ Spielgeräte

Aménagements d'aires de jeux

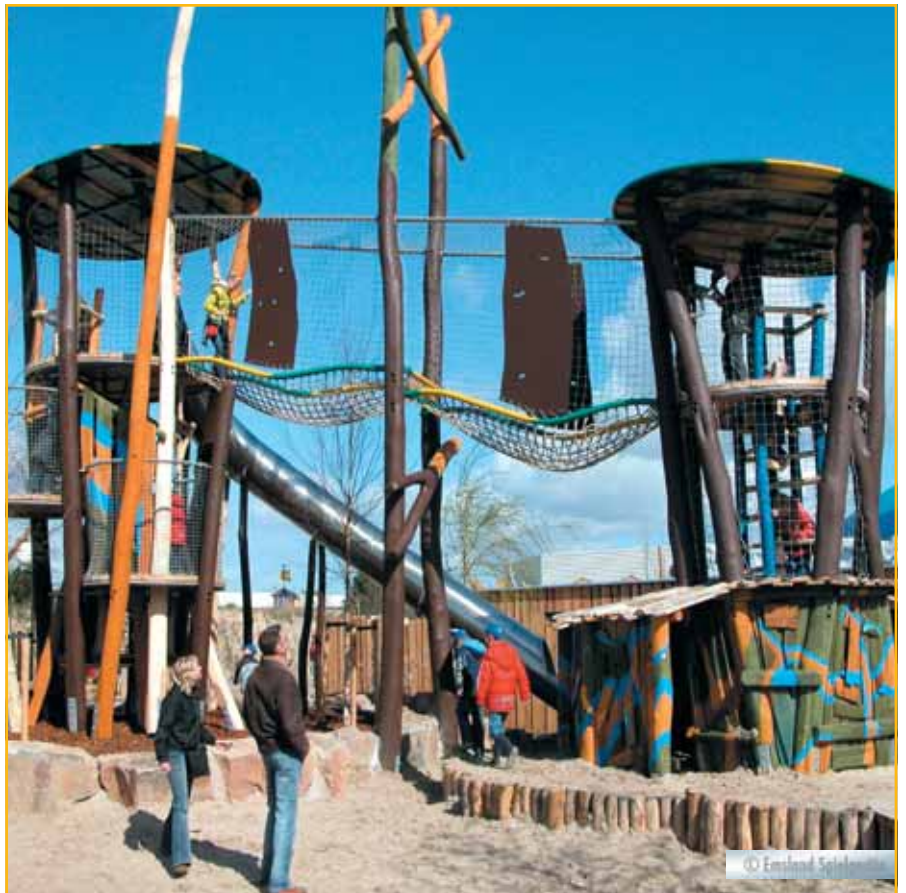

Le Dolfinarium

Aménagements d'aires de jeux





Haltern, le port

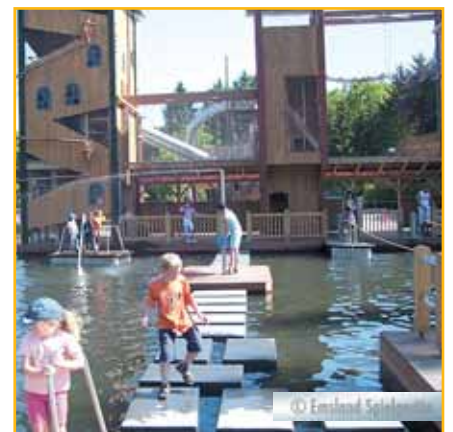

Aménagements d'aires de jeux





Le Bioscope



Aménagements d'aires de jeux



Aménagements d'aires de jeux

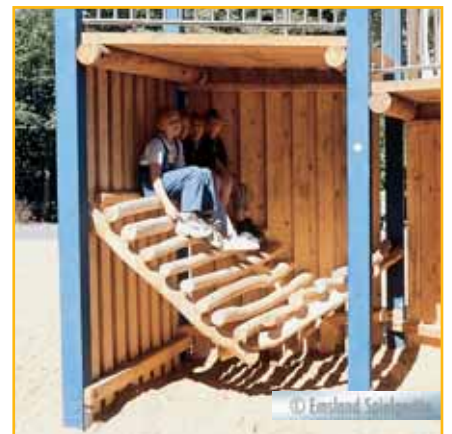

Référence GAT 003700R

Aménagements d'aires de jeux

Référence GAT 003700R

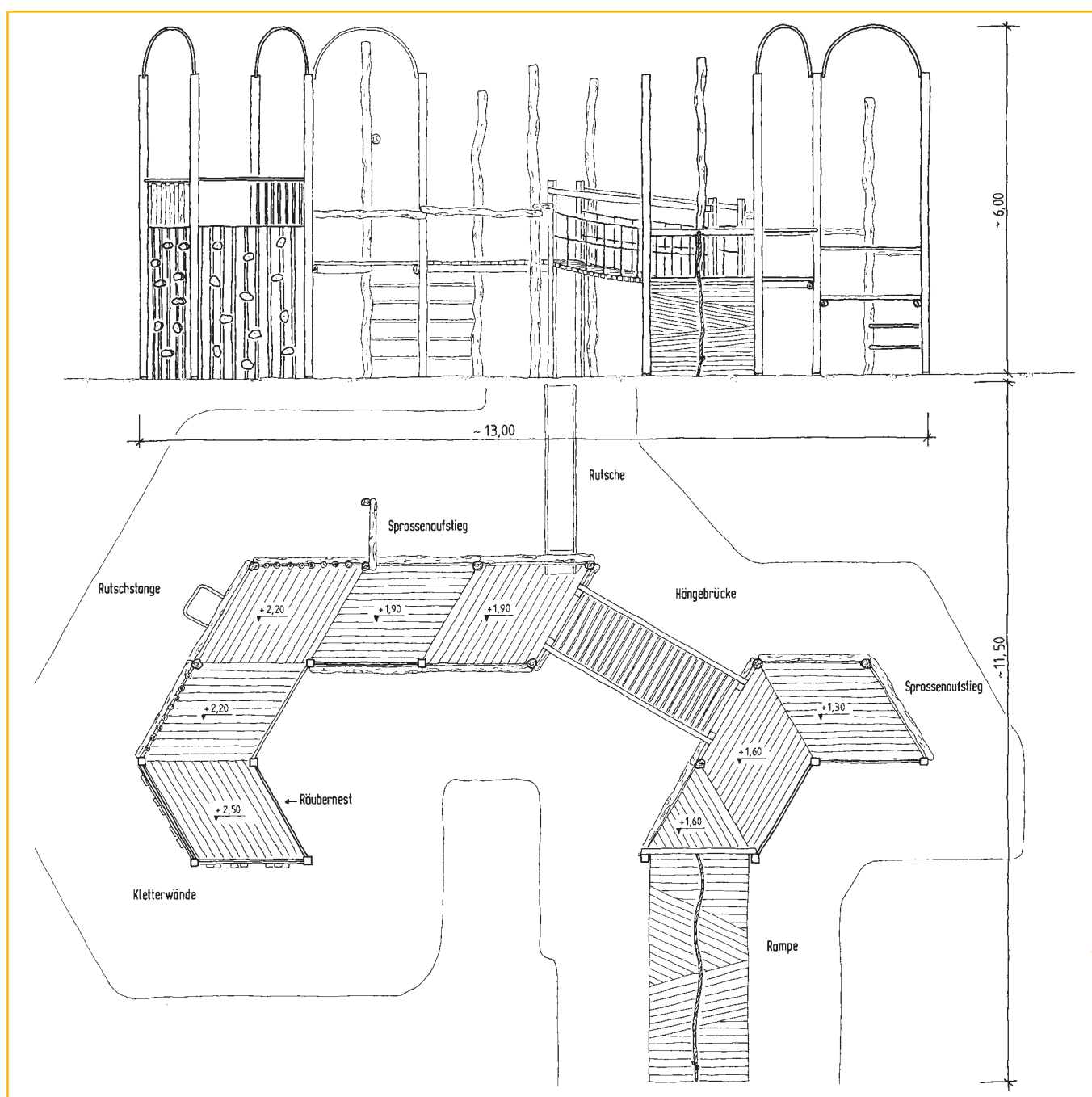

Aménagements d'aires de jeux

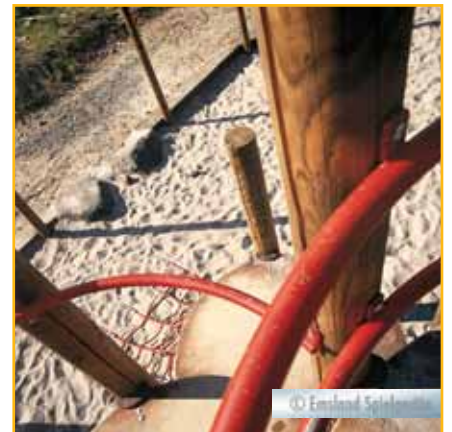

Référence 083000



Aménagements d'aires de jeux

Référence 083000D, L, V, VL

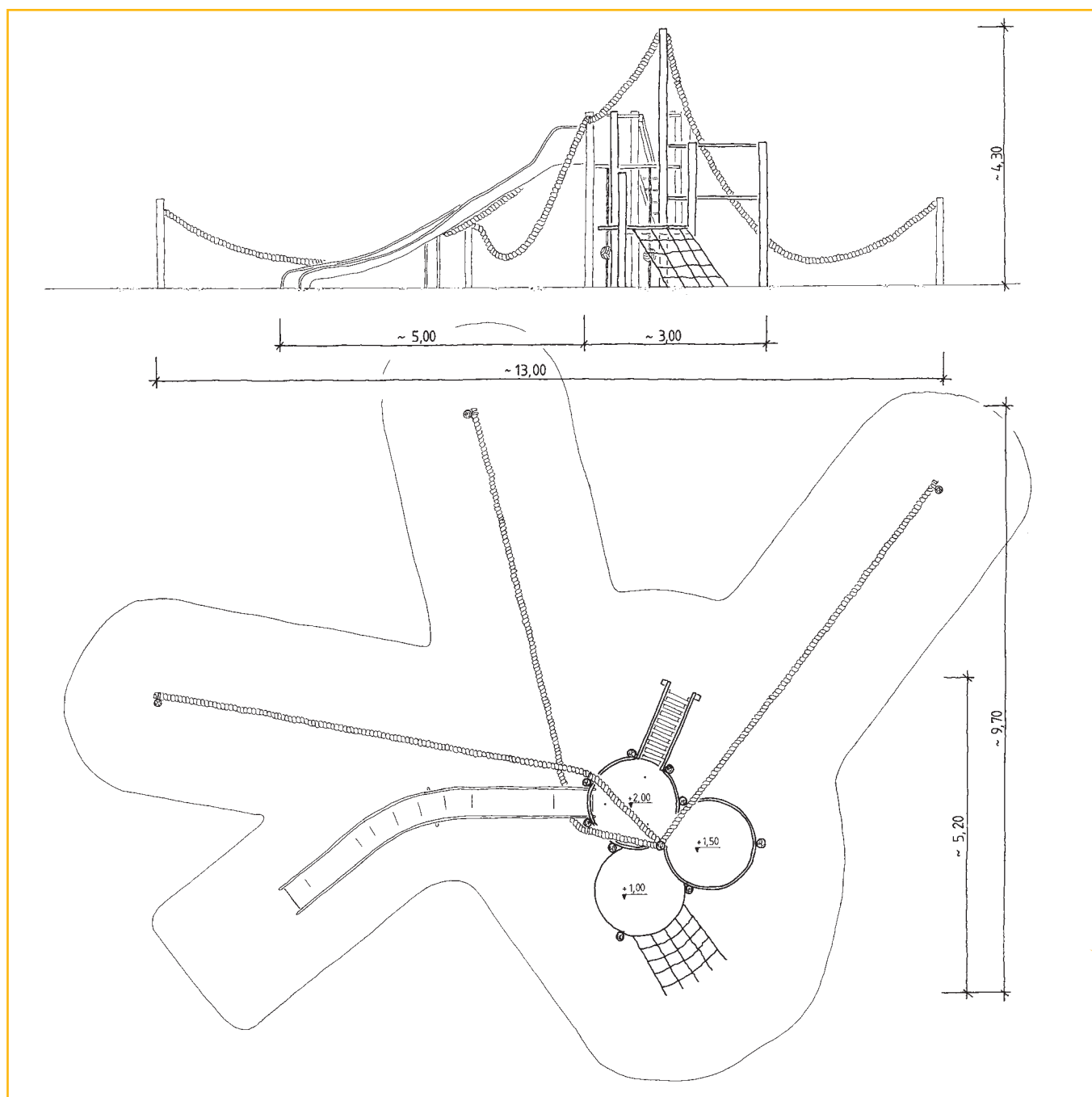

Aménagements d'aires de jeux

Kinderland
Emsland Spielgeräte



Référence 085000R

Aménagements d'aires de jeux

Référence 085000R

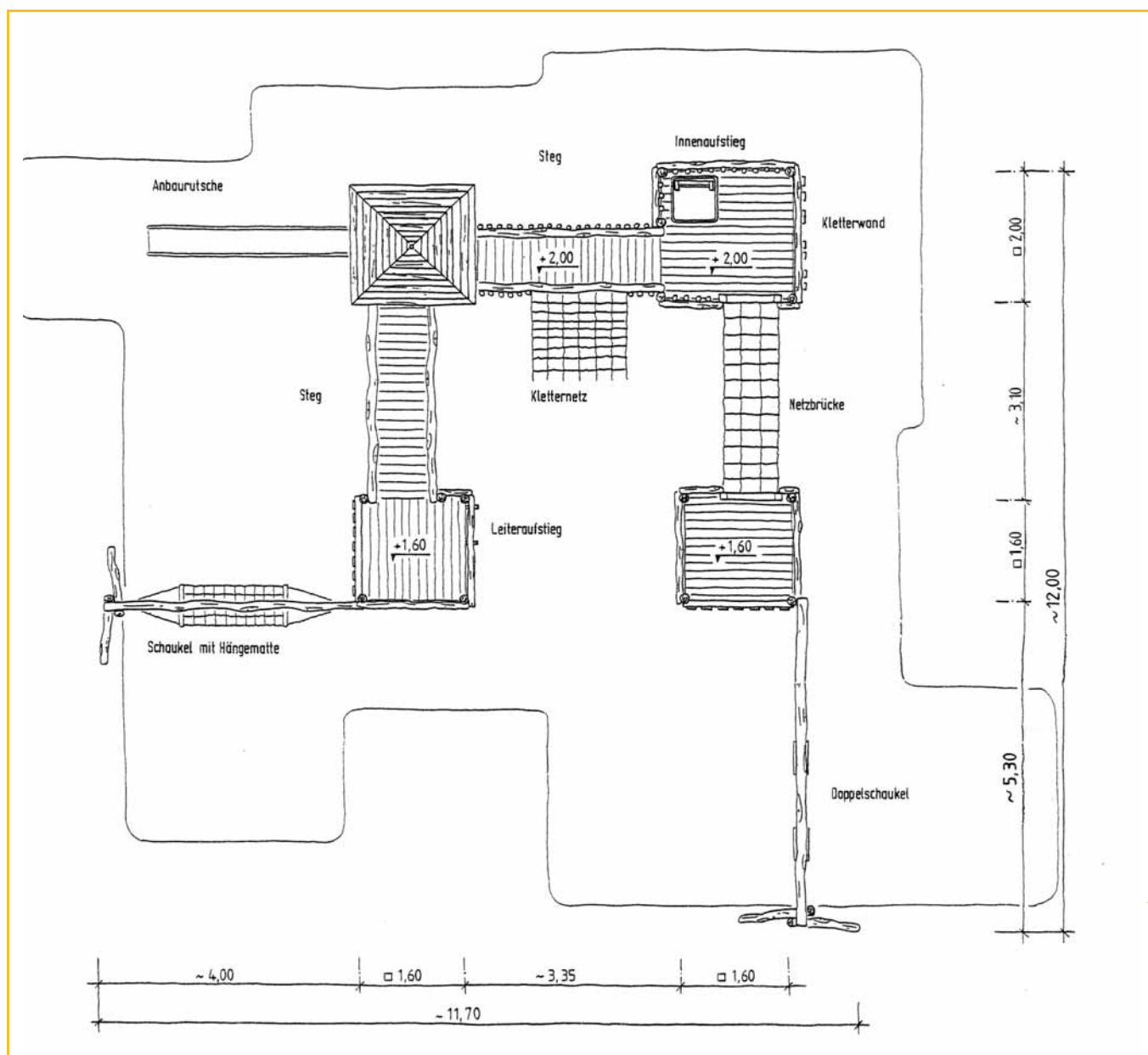



Kinderland
Emsland Spielgeräte

Aménagements d'aires de jeux



Référence 082900R

Aménagements d'aires de jeux

Référence 082900R

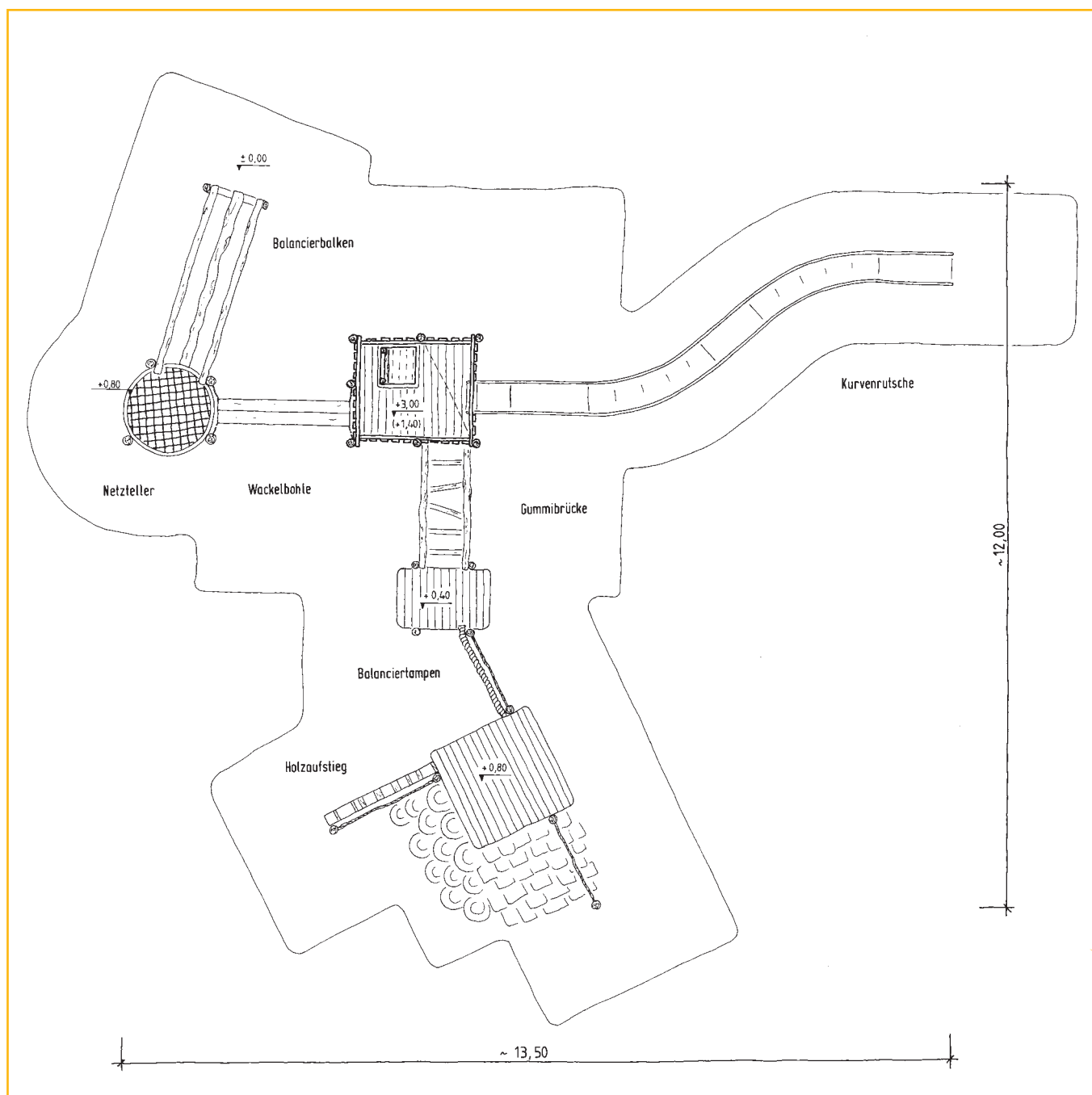



Référence 082686

Aménagements d'aires de jeux

Référence 082686D, VL

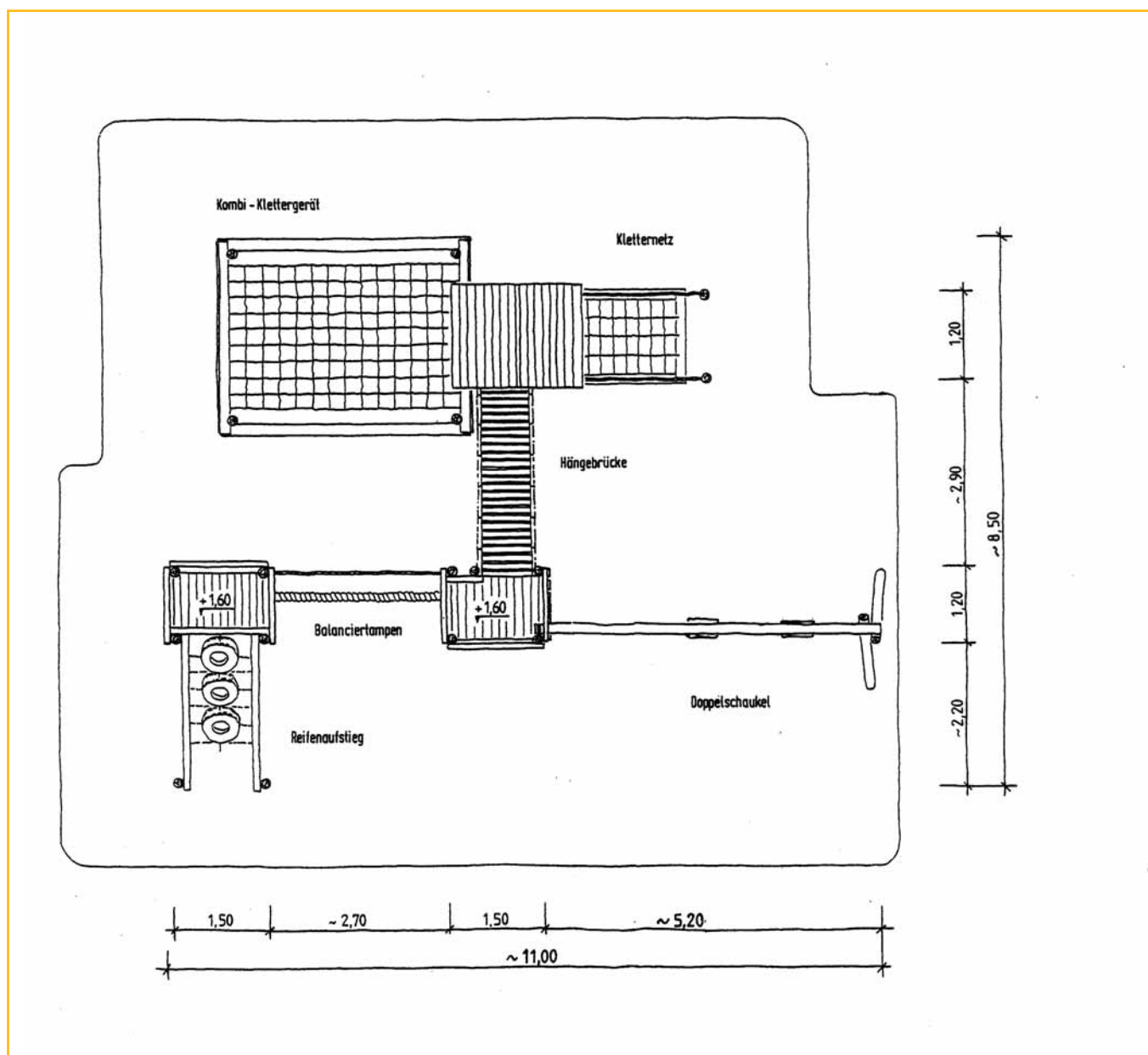

Aménagements d'aires de jeux



Référence 085040

Aménagements d'aires de jeux

Référence 085040R

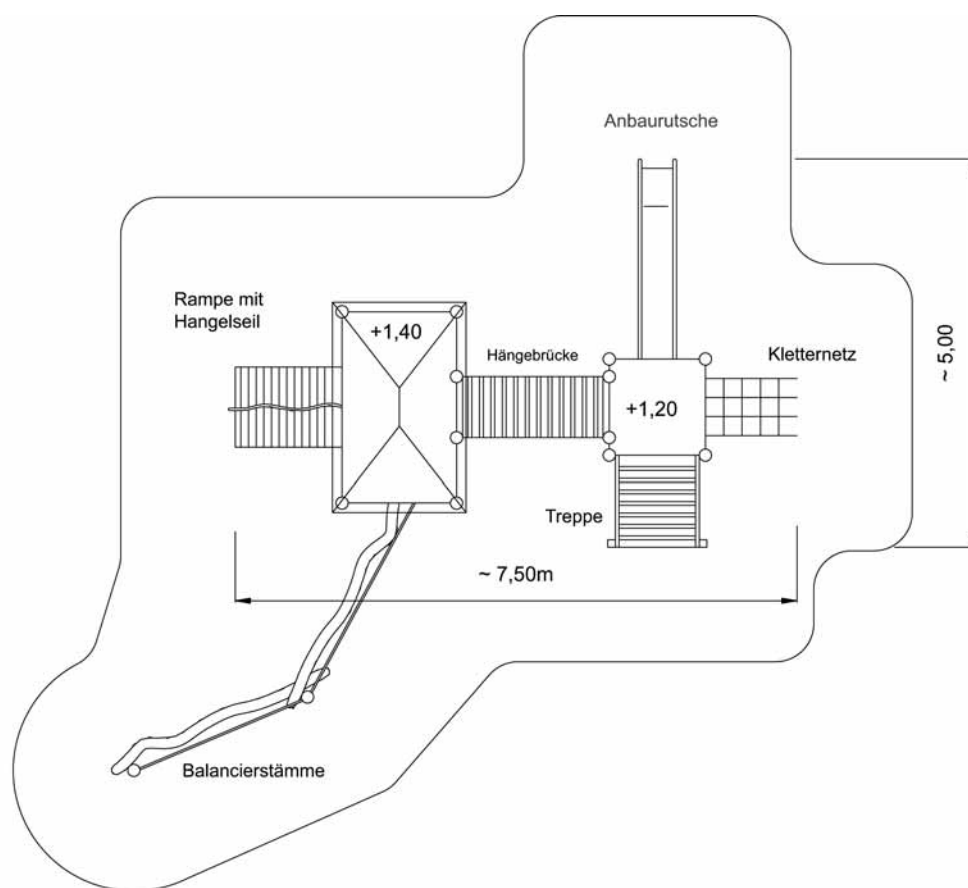

Aménagements d'aires de jeux



Référence GAT 112000-05



Aménagements d'aires de jeux

Référence GAT 112000-05

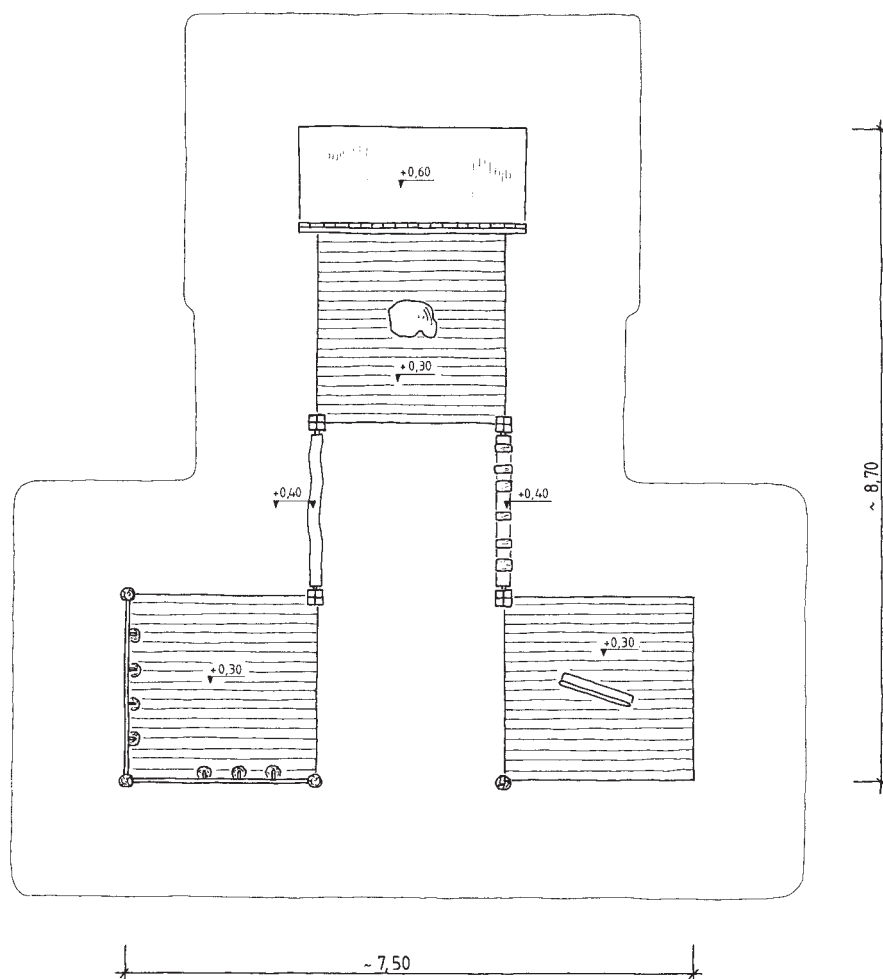

Aménagements d'aires de jeux

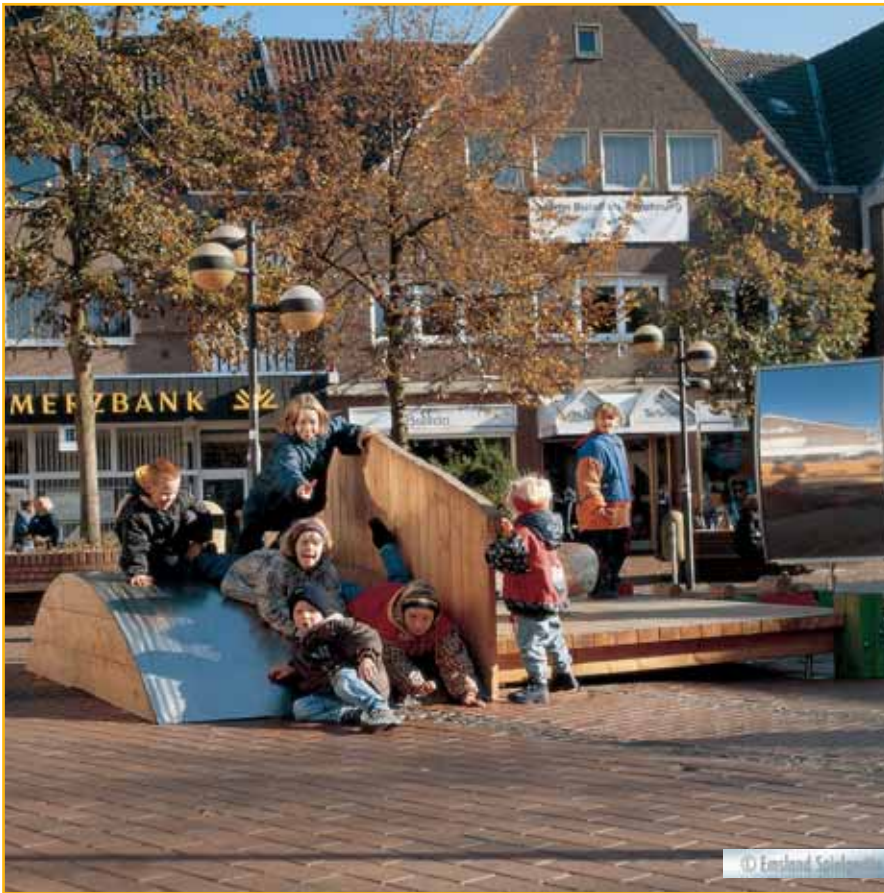

Eléments Kindercity



Aménagements d'aires de jeux

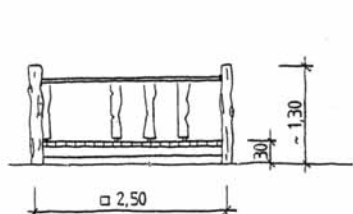

□ 2,50

~ 1,30

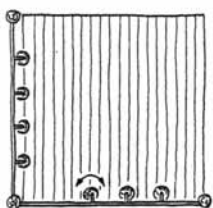

PODEST MIT DREHSÄULEN
GAT 11 2000 D

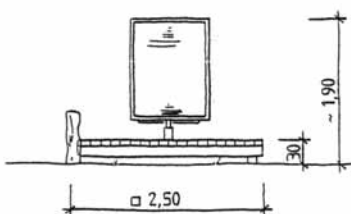

□ 2,50

~ 1,90

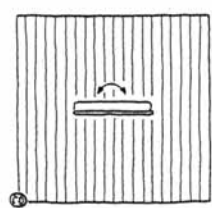

PODEST MIT SPIEGELWAND
GAT 11 2001 D

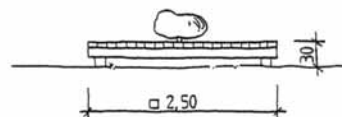

□ 2,50

30

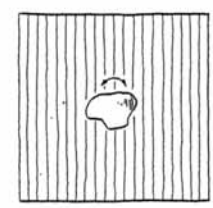

PODEST MIT FINDLING
GAT 11 2002 D

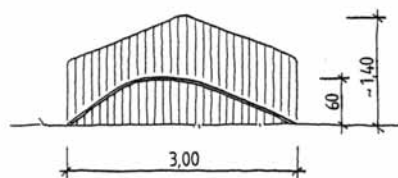

3,00

~ 1,40

60



RUTSCHENHÜGEL
GAT 11 2003 E

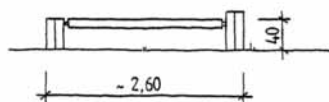

~ 2,60

40



WACKEL-BALANCIERBALKEN
GAT 11 2004 D

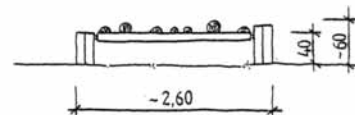

~ 2,60

40

60

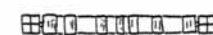

WACKEL-BALANCIERKÖRPER
GAT 11 2005 D

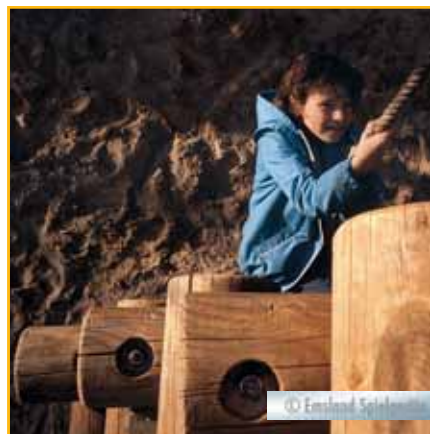

Bateau

Référence 082970

Aménagements d'aires de jeux

Référence 082970D, R

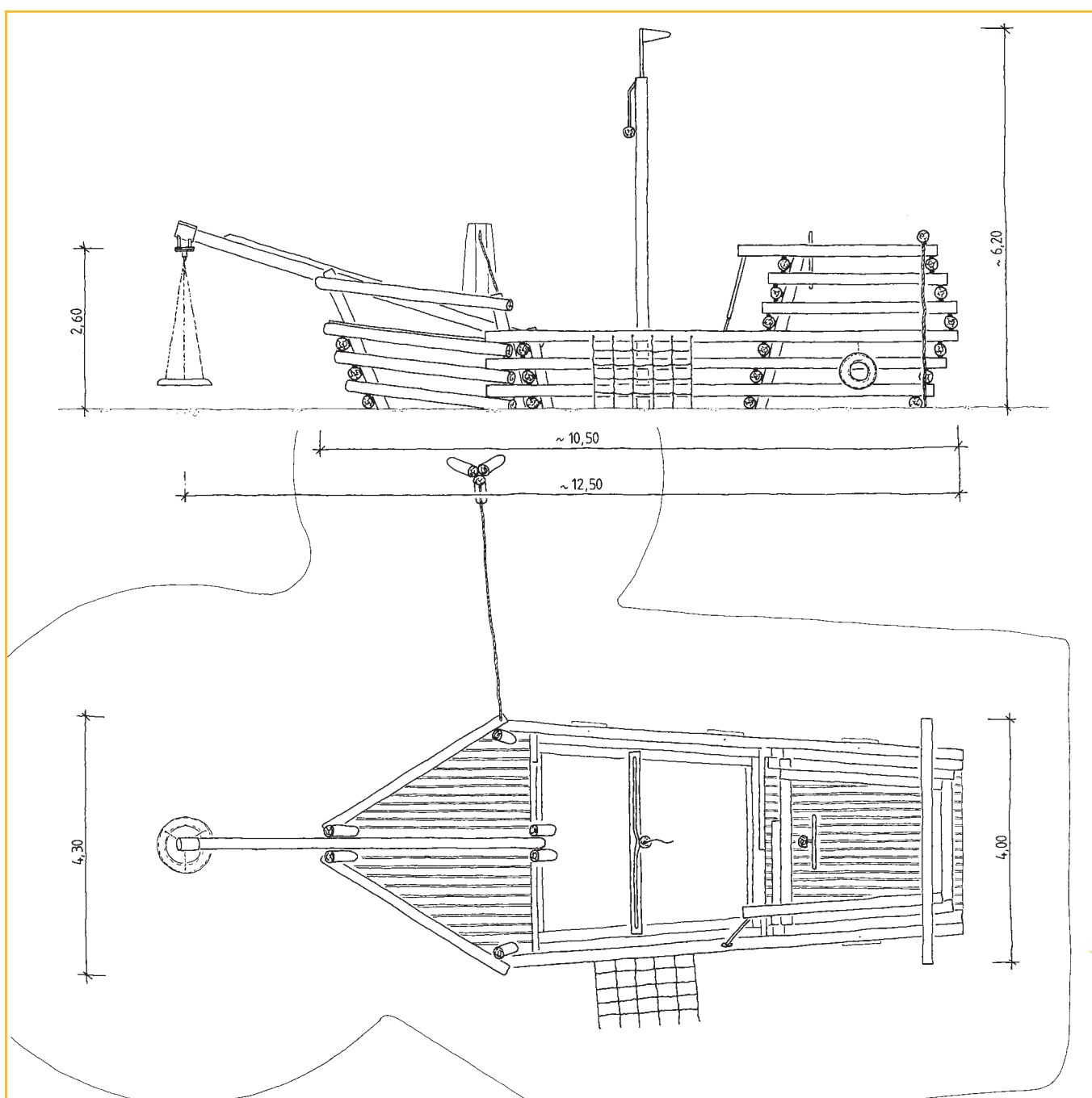



Kinderland
Emsland Spielgeräte

Aménagements d'aires de jeux



Bateau sur mesure

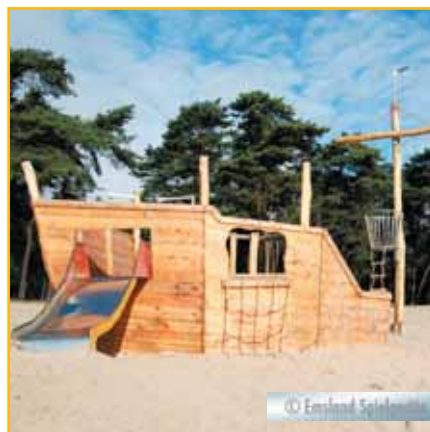

Aménagements d'aires de jeux





Moduludus Eléments 1



Aménagements d'aires de jeux

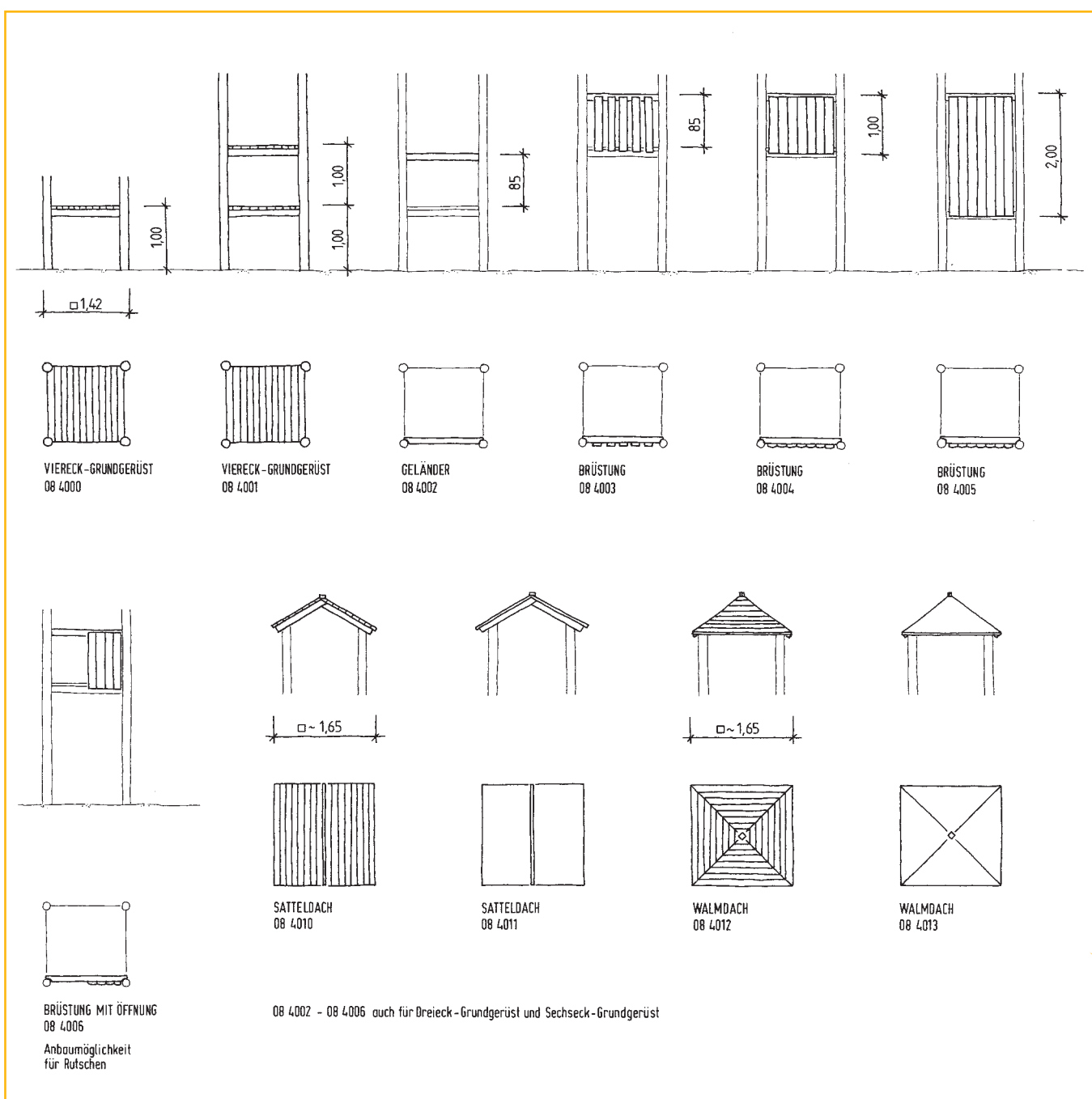



Kinderland
Emsland Spielgeräte

Aménagements d'aires de jeux



Moduludus Eléments 2



Aménagements d'aires de jeux

Moduludus Éléments 2

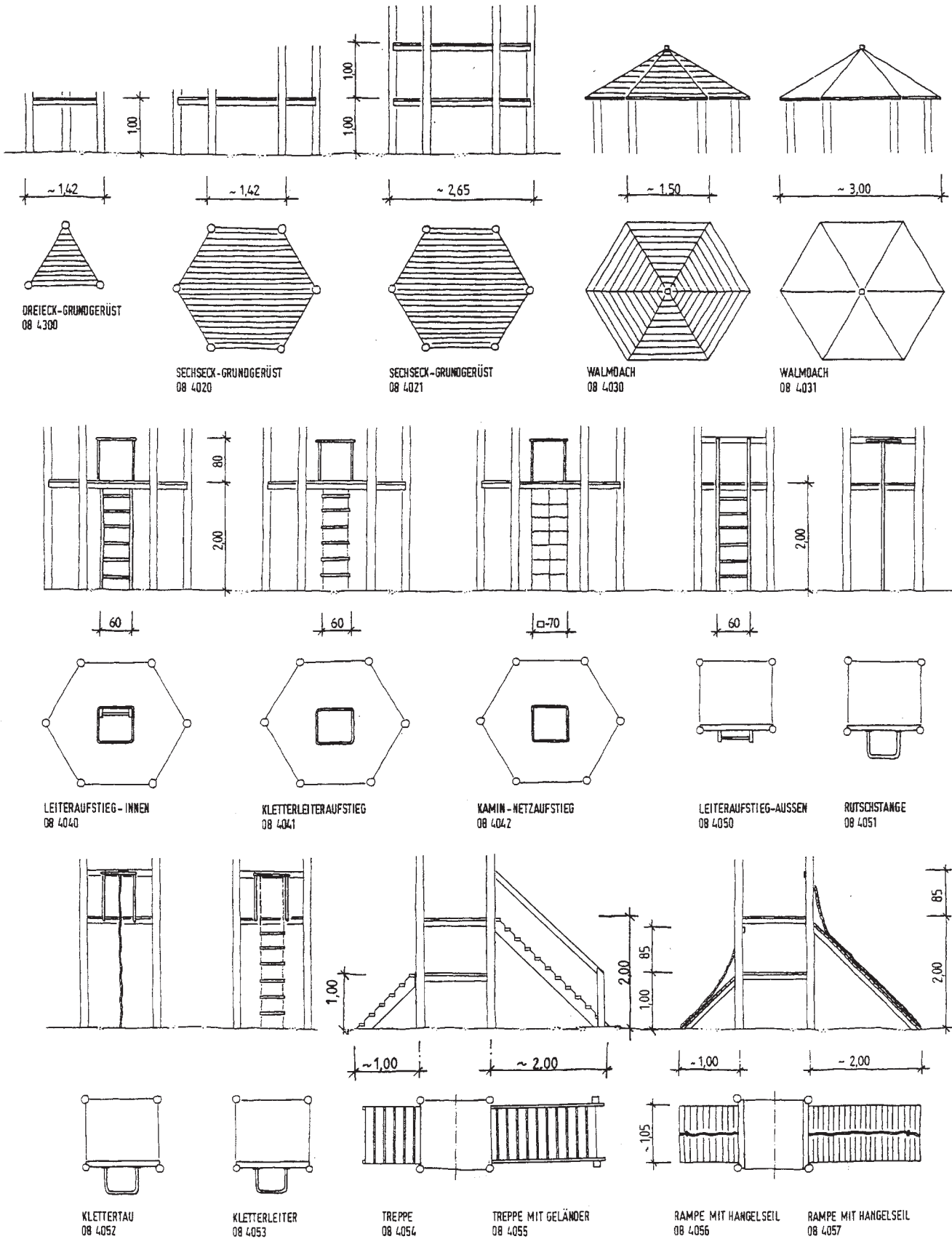



Moduludus Eléments 3

Aménagements d'aires de jeux

Moduludus Éléments 3

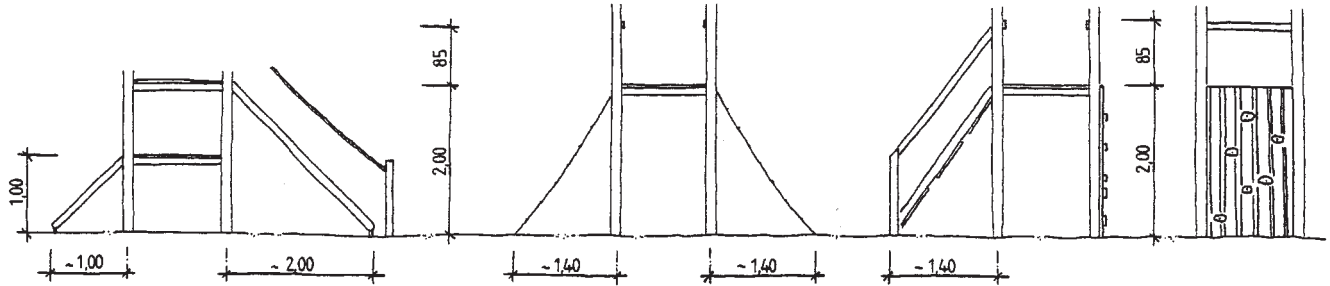

SCHRÄGES KLETTERNETZ 08 4058 SCHRÄGES KLETTERNETZ 08 4059 SCHRÄGES KLETTERNETZ-TRAPEZ 08 4060 SCHRÄGES KLETTERNETZ 08 4068 SCHRÄGER REIFENAUFSTIEG 08 4061 KLETTERWAND 08 4098

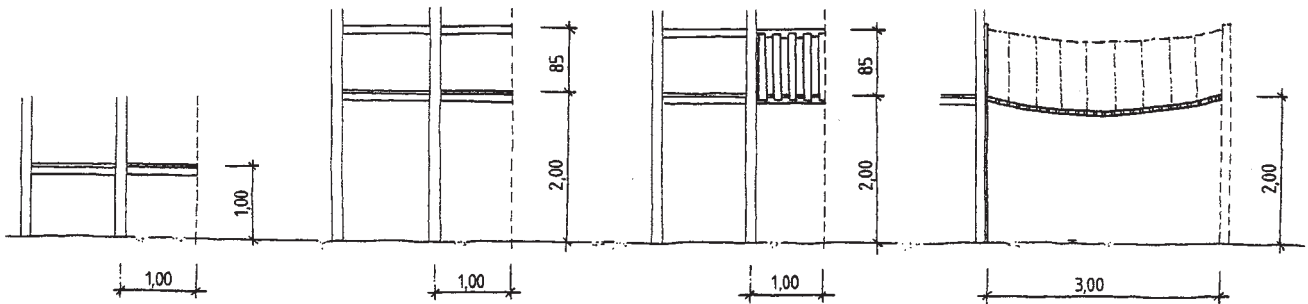

BRÜCKE 08 4070 BRÜCKE MIT GELÄNDER 08 4071 BRÜCKE MIT BRÜSTUNG 08 4072 HÄNGEBRÜCKE 08 4073

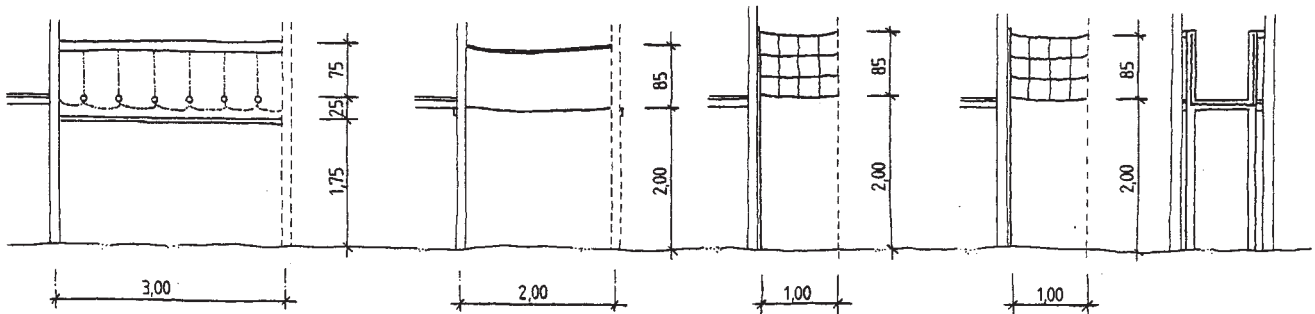

WACKELBRÜCKE 08 4074 GUMMIBANDBRÜCKE 08 4075 NETZBRÜCKE 08 4076 NETZBRÜCKE 08 4067



Moduludus
Eléments 4



Aménagements d'aires de jeux

Moduludus Éléments 4

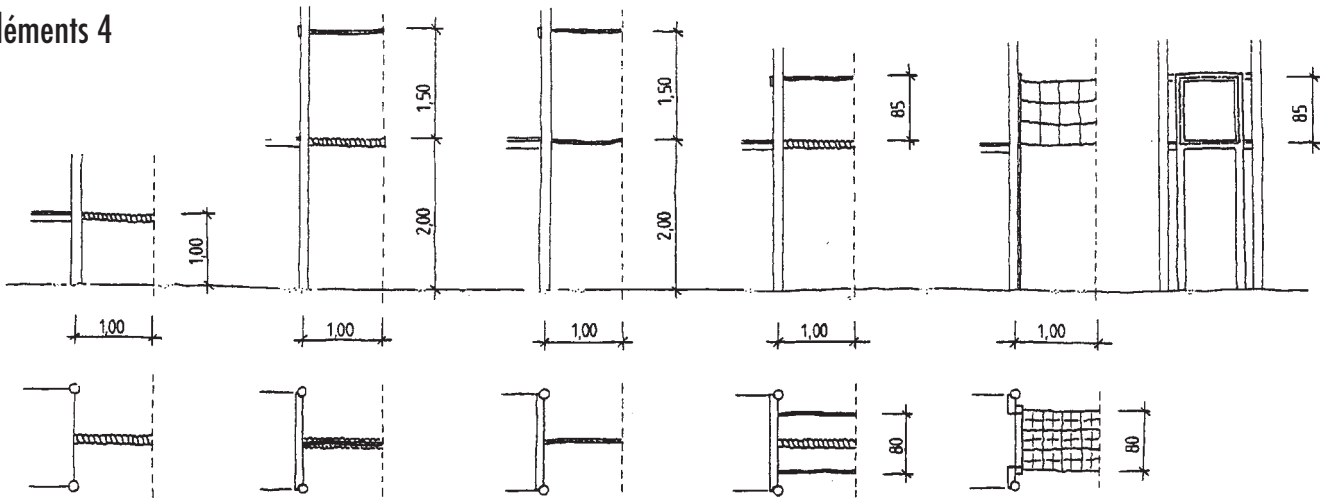

TAMPENBRÜCKE # 10
ØB 4080
TAMPENBRÜCKE # 20
ØB 4081

TAMPENBRÜCKE MIT HANDSEIL
ØB 4082

SEILBRÜCKE MIT HANDSEIL
ØB 4083

TAMPENBRÜCKE MIT 2 HANDSEILEN
ØB 4084

NETZTUNNEL
ØB 4077

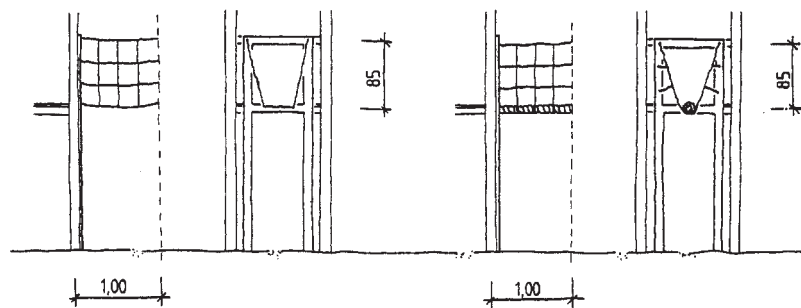

NETZBRÜCKE
ØB 4078

NETZBRÜCKE MIT TAMPEN
ØB 4079

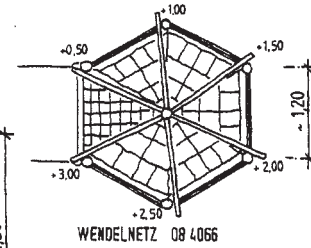
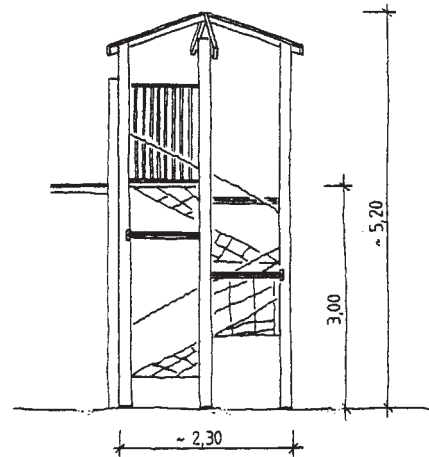

WENDELNETZ ØB 4066

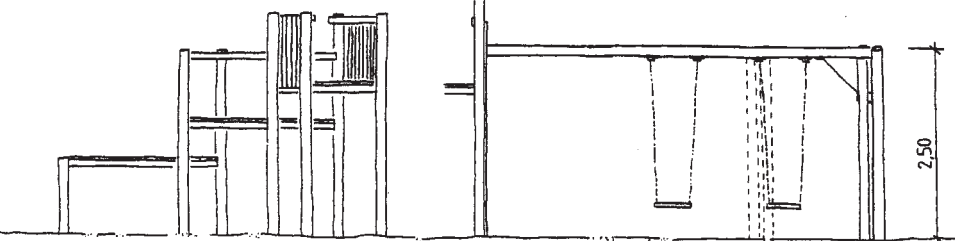

EINFACH-ANBAUSCHAUKELE
ØB 4090

DOPPEL-ANBAUSCHAUKELE
ØB 4091

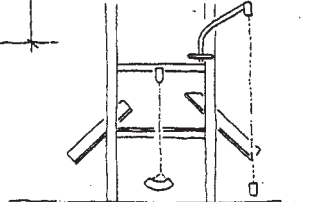

SANDRINNE
ØB 4096

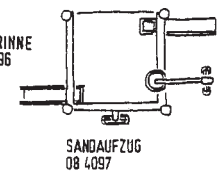

SANDAUFZUG
ØB 4097

SANDSCHÜTTE
ØB 4095

DREHBARER
SANDAUFZUG
ØB 4094

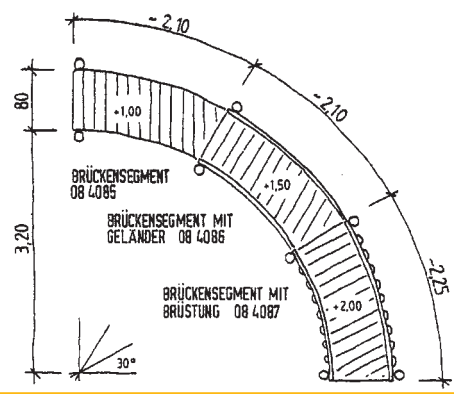

BRÜCKENSEGMENT
ØB 4085

BRÜCKENSEGMENT MIT
GELÄNDER ØB 4086

BRÜCKENSEGMENT MIT
BRÜSTUNG ØB 4087



Aménagements d'aires de jeux



Référence 082490/1-3



Aménagements d'aires de jeux

Référence 082490/1-3D, R, V, VL

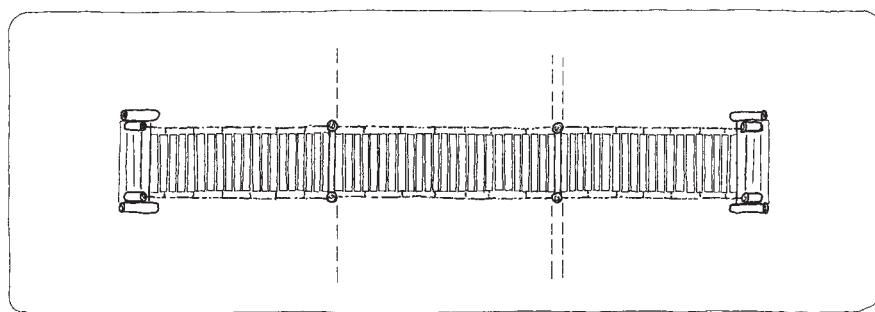
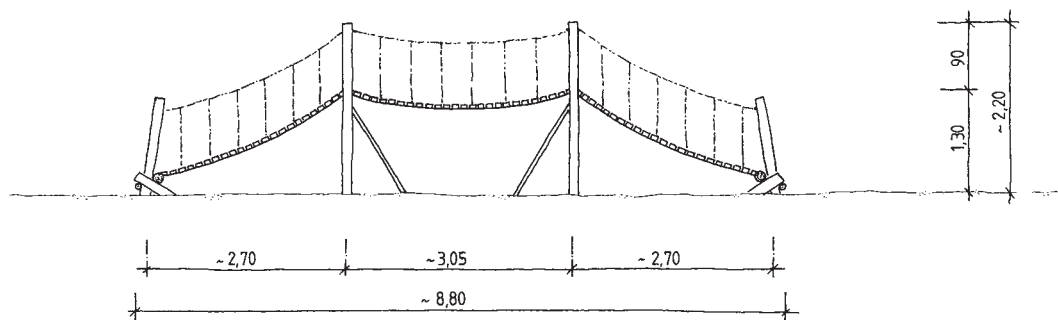

HÄNGEBRÜCKE 08 2490/1

ANBAUHÄNGEBRÜCKE 08 2490/2

RAMPE 08 2490/3



Modules en robinier

Éléments 1



Aménagements d'aires de jeux

Modules en robinier Eléments 1

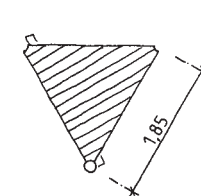
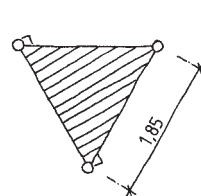
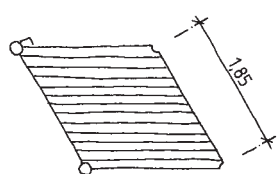
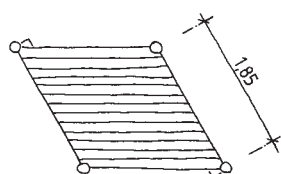
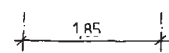
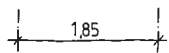
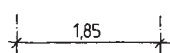
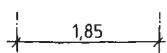
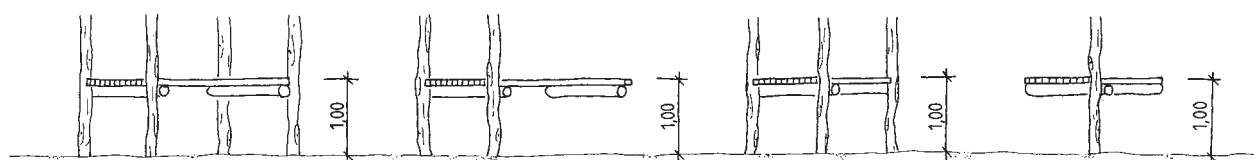

RHOMBEN-PODEST
GAT 00 5000.R

RHOMBEN-ANSCHLUSSPODEST
GAT 00 5001.R

DREIECK-PODEST
GAT 00 5002.R

DREIECK-ANSCHLUSSPODEST
GAT 00 5003.R

Verbindungselemente, wie z.B. Netzbrücken, siehe moduludus - Elemente

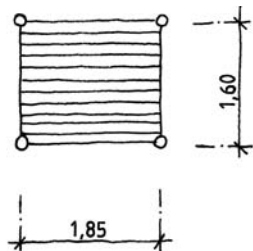
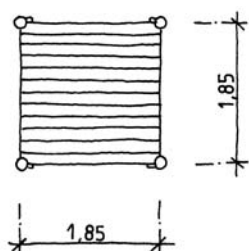

Viereck-Podest
GAT 00 5019R

Rechteck-Podest
GAT 00 5020R



Kinderland
Emsland Spielgeräte

Aménagements d'aires de jeux

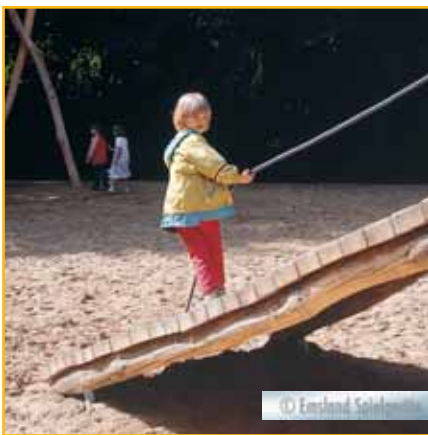

Modules en robinier

Eléments 2

Aménagements d'aires de jeux

Modules en robinier Eléments 2

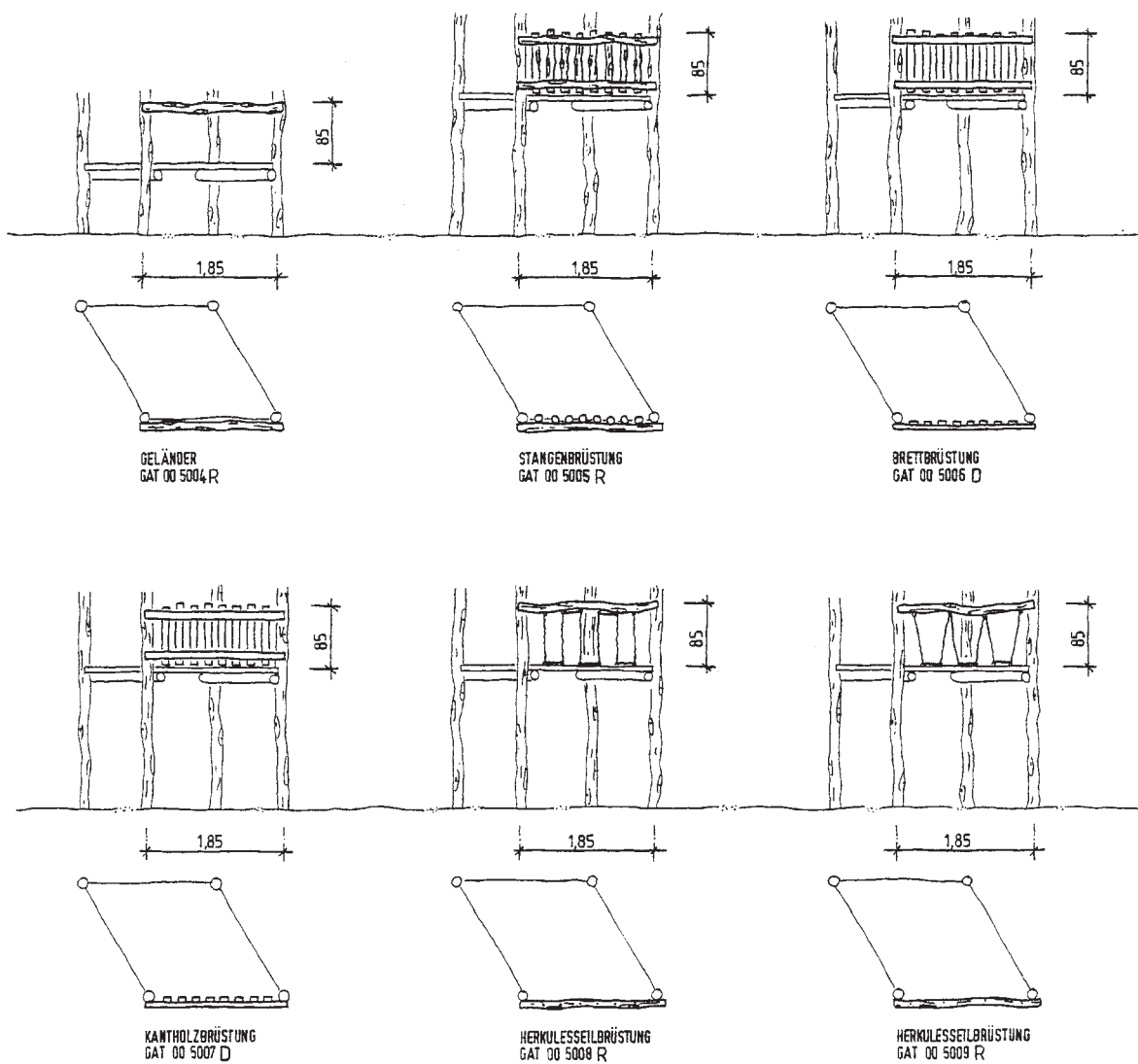



Kinderland
Emsland Spielgeräte

Aménagements d'aires de jeux



Modules en robinier

Eléments 3

Aménagements d'aires de jeux

Modules en robinier

Éléments 3

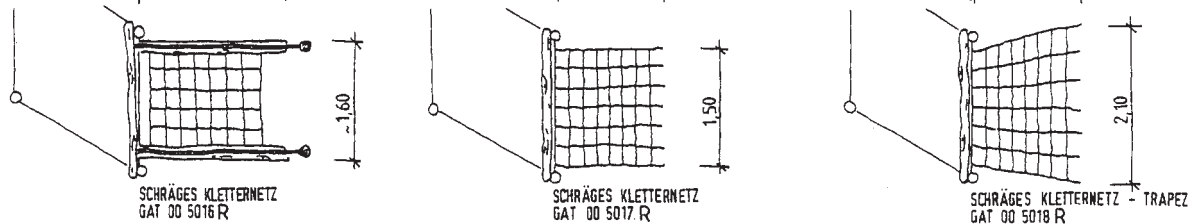
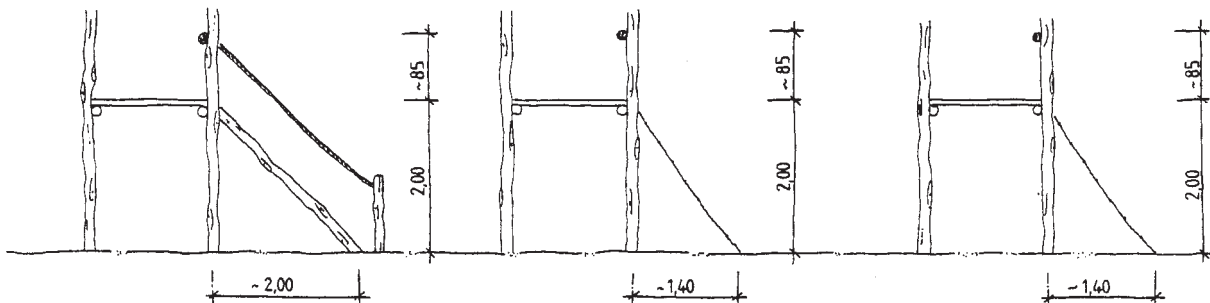
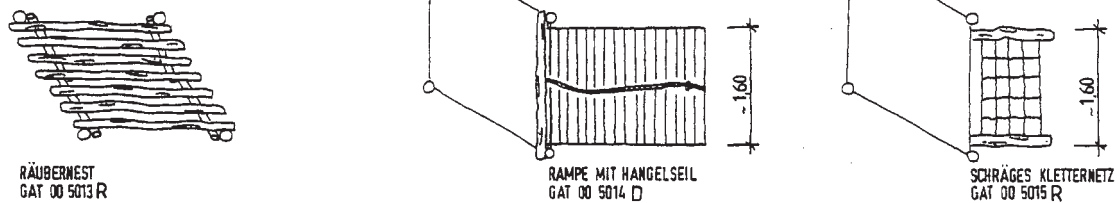
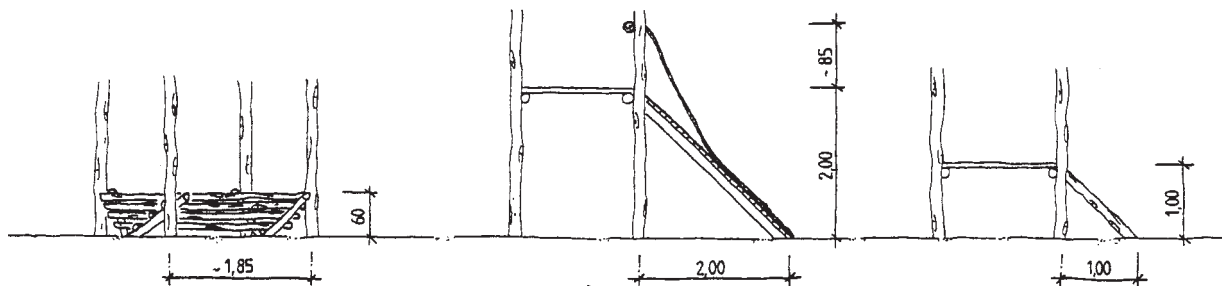
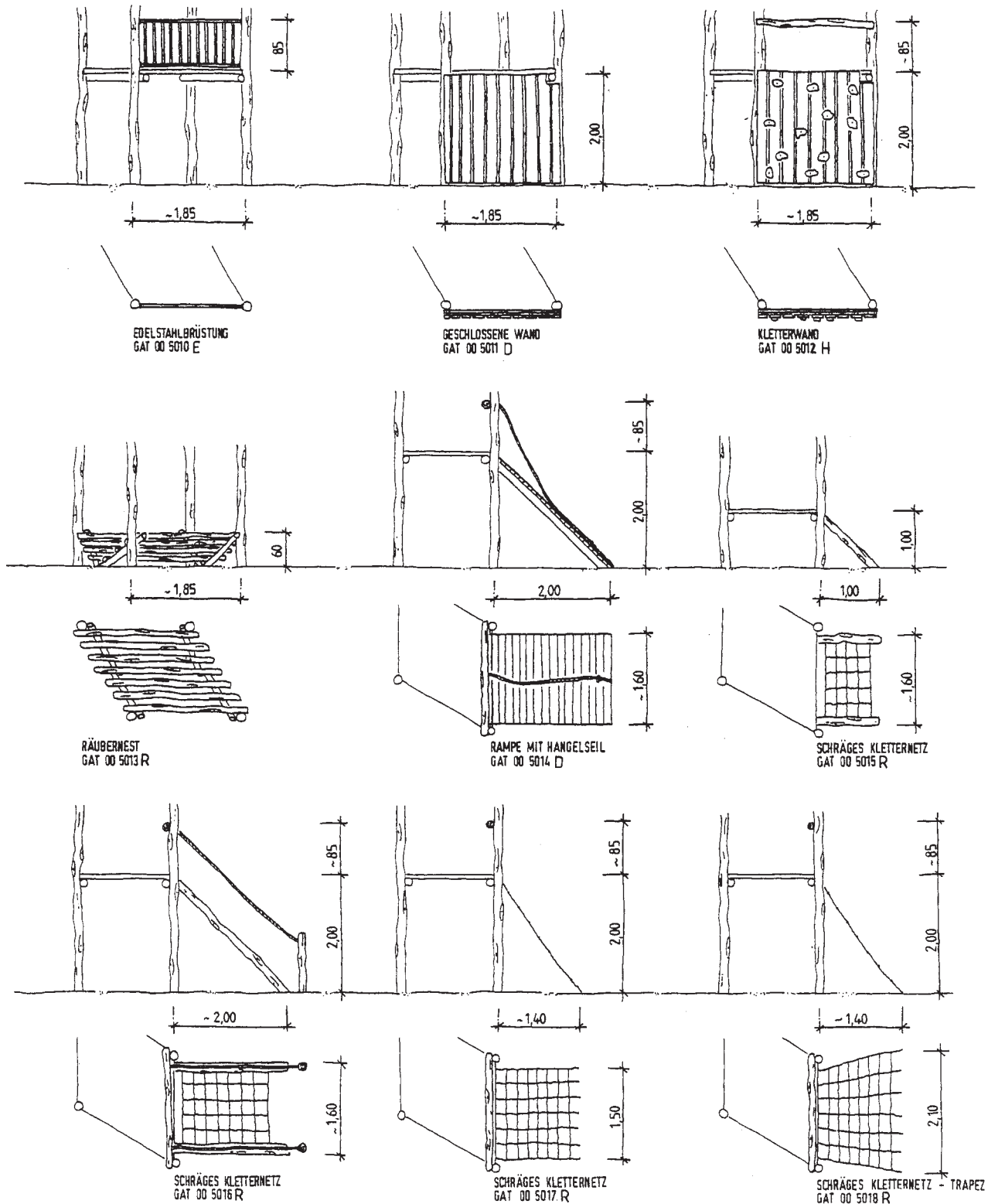

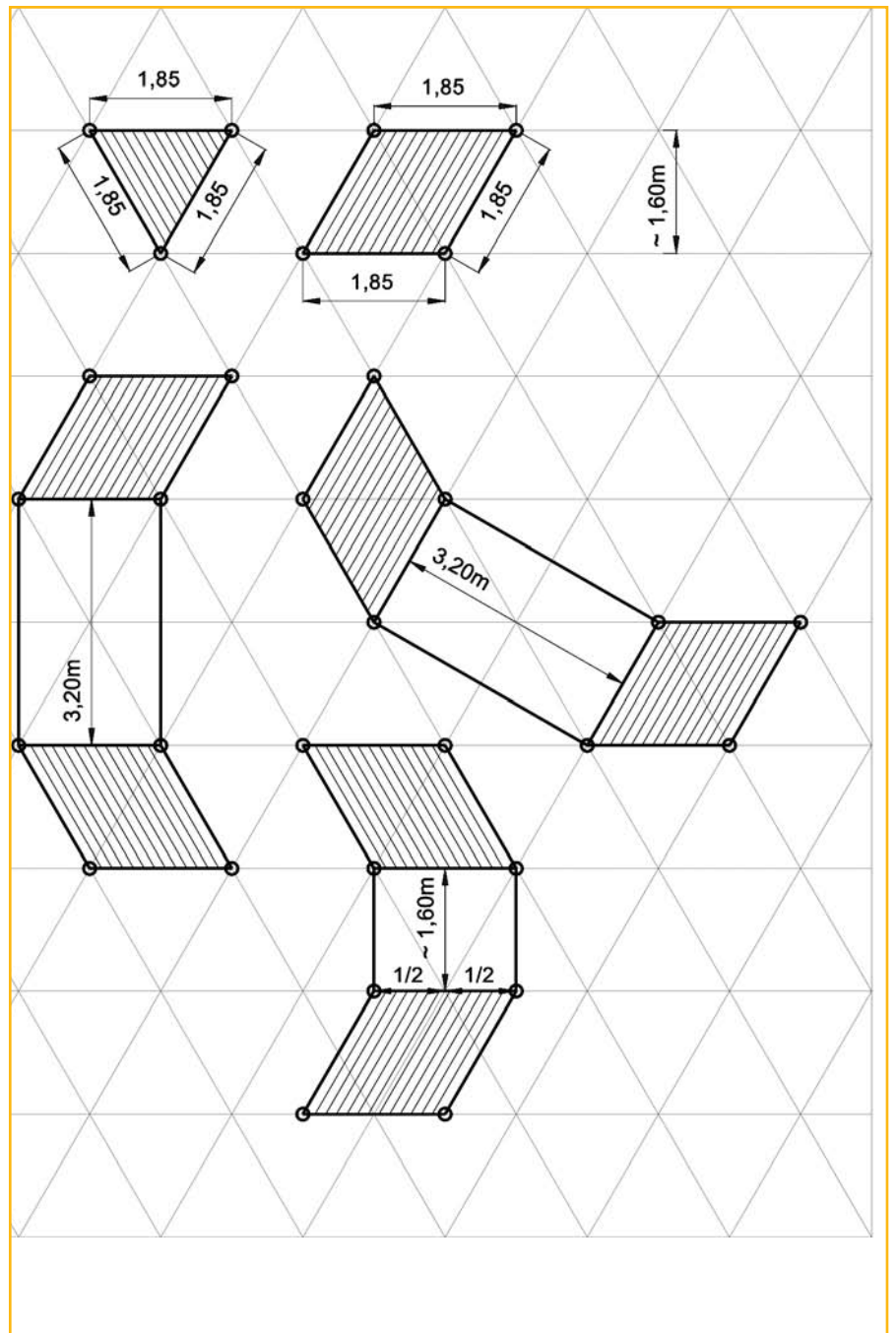

Aménagements d'aires de jeux

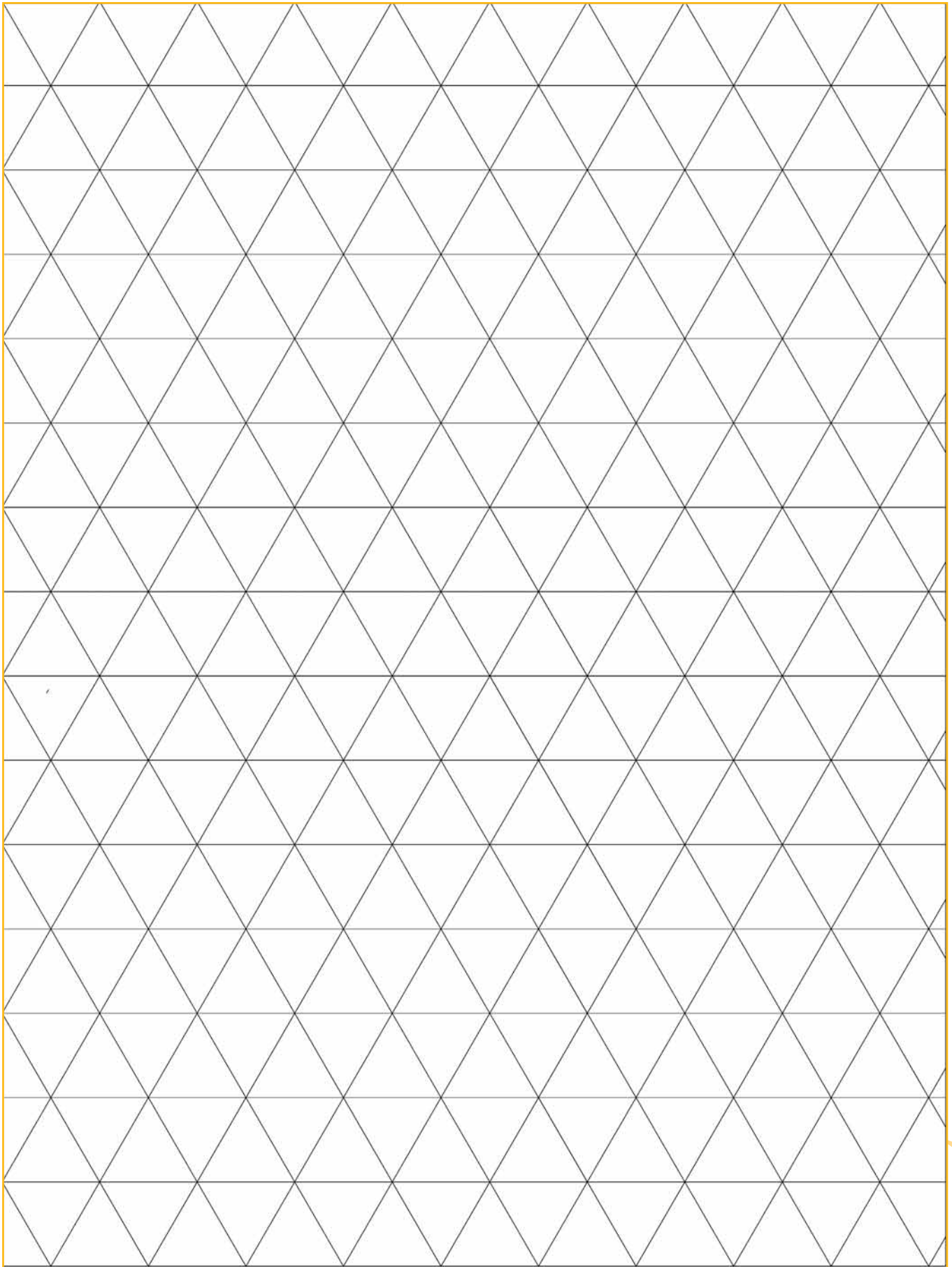



Compléments d'aménagement d'aires de jeux





Référence 113510/2L
Référence 113510/3L

Compléments d'aménagement d'aires de jeux

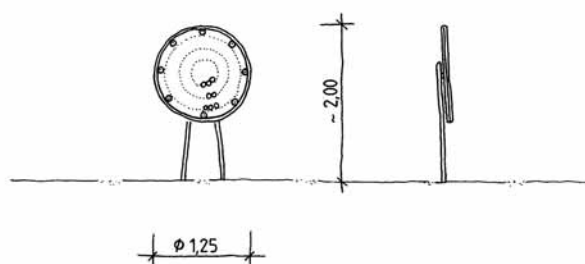

11 3510/2
mit Messingstiften



Compléments d'aménagement d'aires de jeux





Compléments d'aménagement d'aires de jeux









Projets pour personnes à mobilité réduite



Projets pour personnes à mobilité réduite

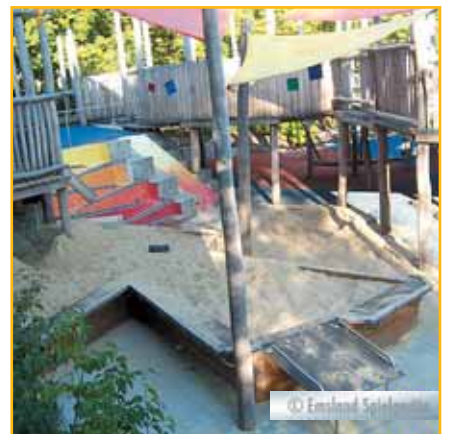

Projets pour personnes à mobilité réduite





Projets pour personnes à mobilité réduite





Projets pour personnes à mobilité réduite

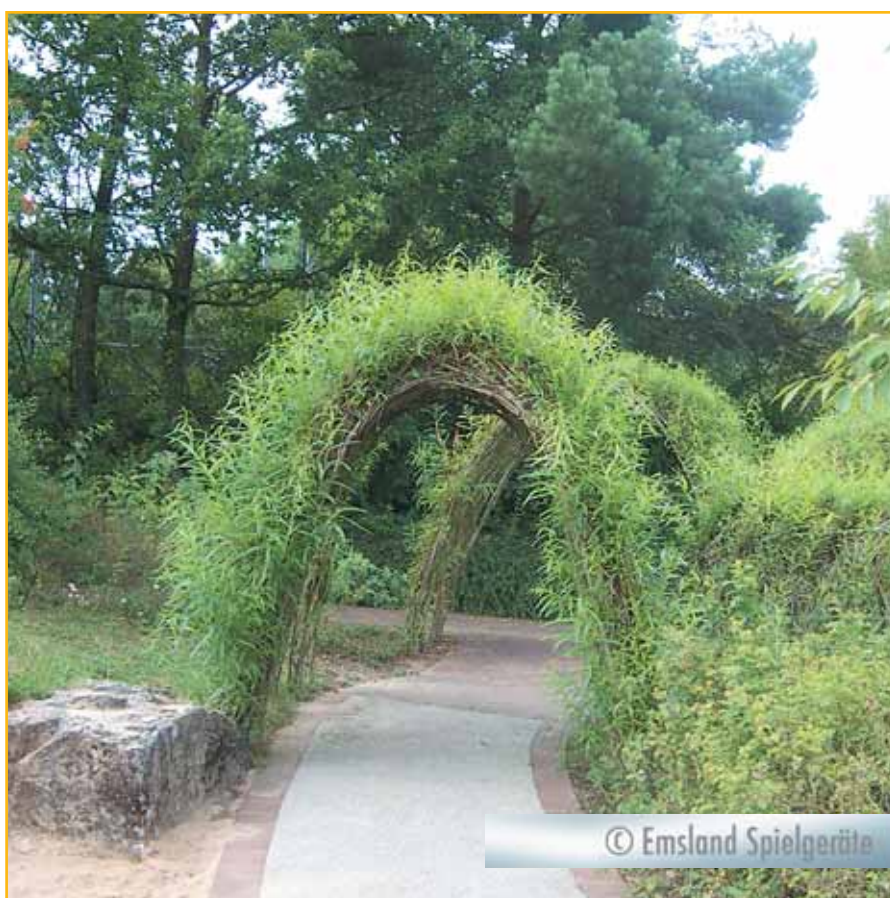

Projets pour personnes à mobilité réduite



Projets pour personnes à mobilité réduite

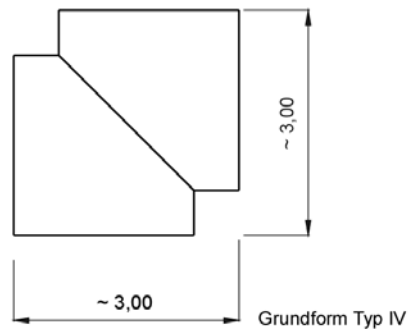
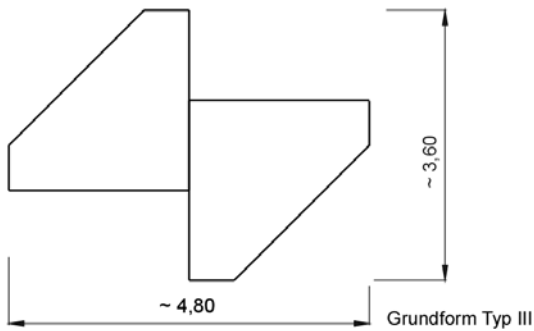
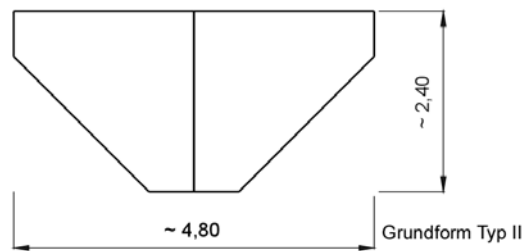
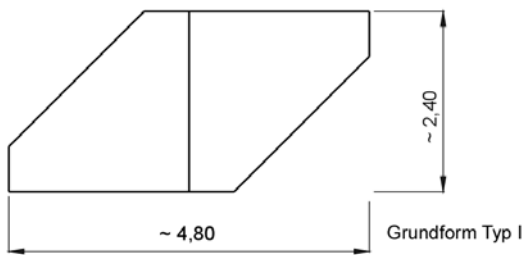
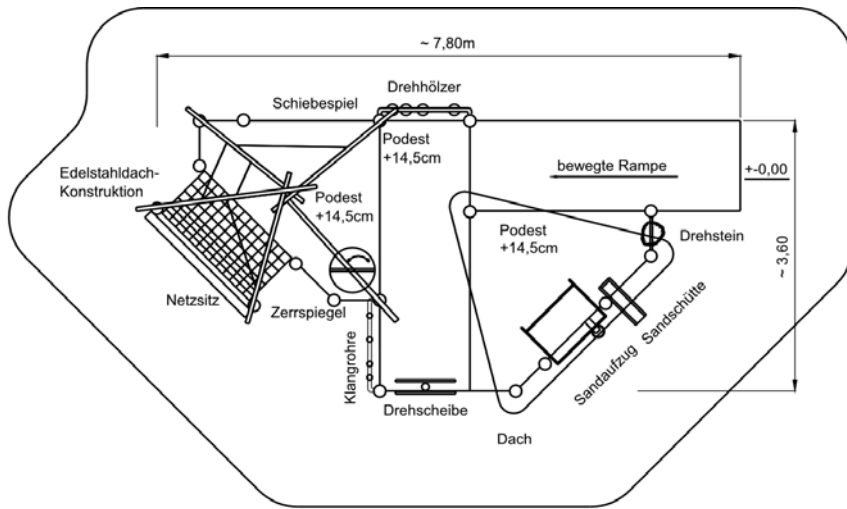

Jeux d'eau et de sable



Jeux d'eau en inox - Partie 1

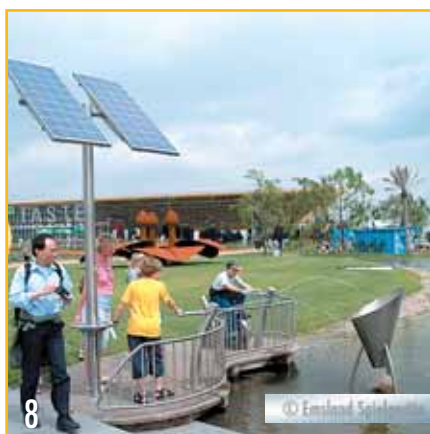

Jeux d'eau et de sable

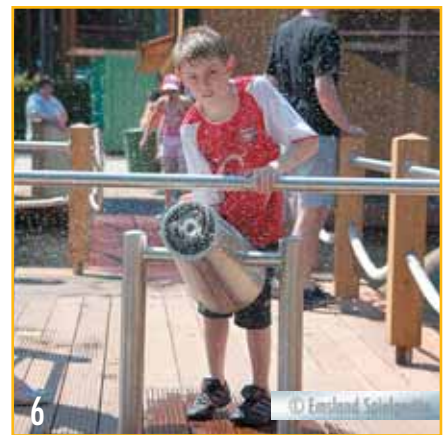

Jeux d'eau et de sable

Kinderland
Emsland Spielgeräte

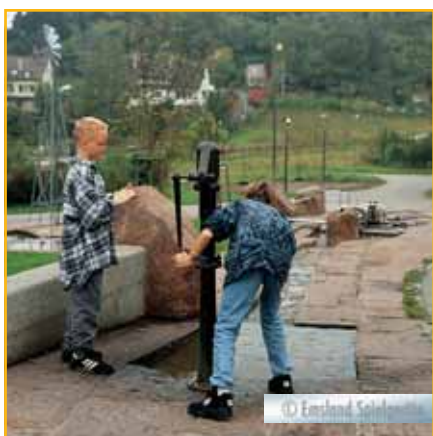

Jeux d'eau en inox- Partie 2



Jeux d'eau et de sable

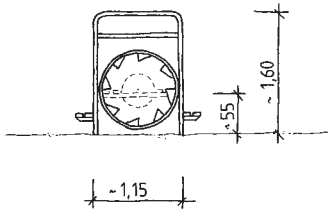

WASSERRAD MIT LAUFTROMMEL
09 6044

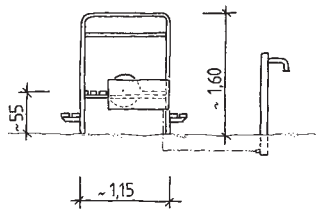

TRETPUMPE
09 6045

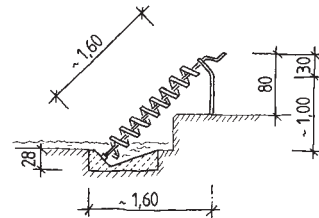

OFFENE ARCHIMEDISCHE SPIRALE
09 6048

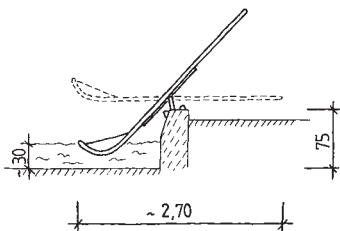
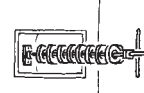
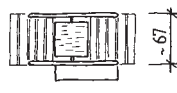
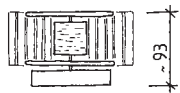

SCHÖPFLÖFFEL
09 6049

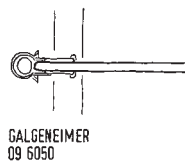
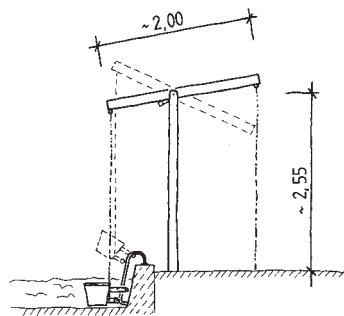

GALGENEIMER
09 6050



Kinderland
Emsland Spielgeräte

Jeux d'eau et de sable



Jeux d'eau et de sable



Jeux d'eau et de sable

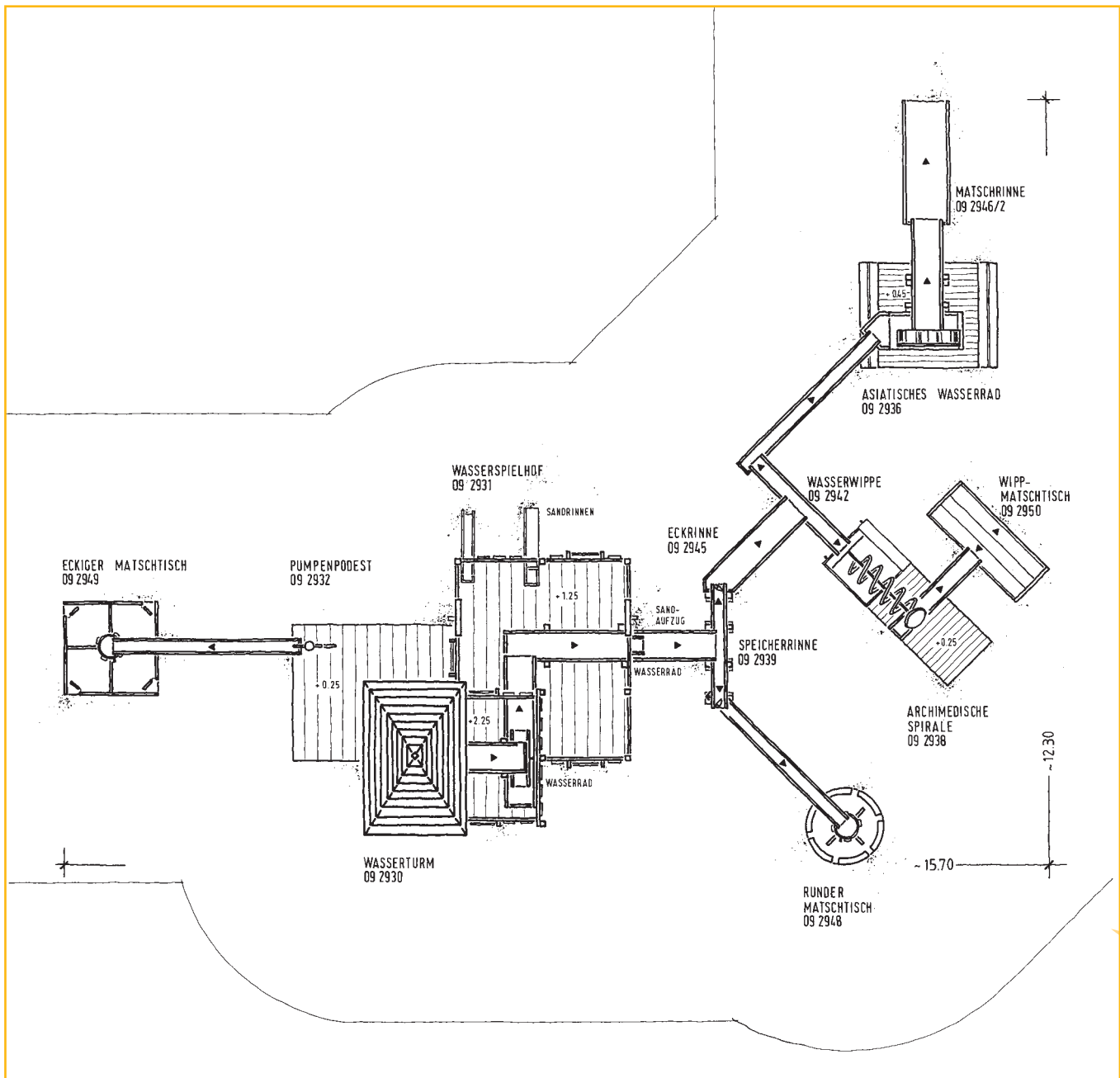

Jeux d'eau et de sable



Jeux d'eau et de sable

Jeux d'eau et de sable

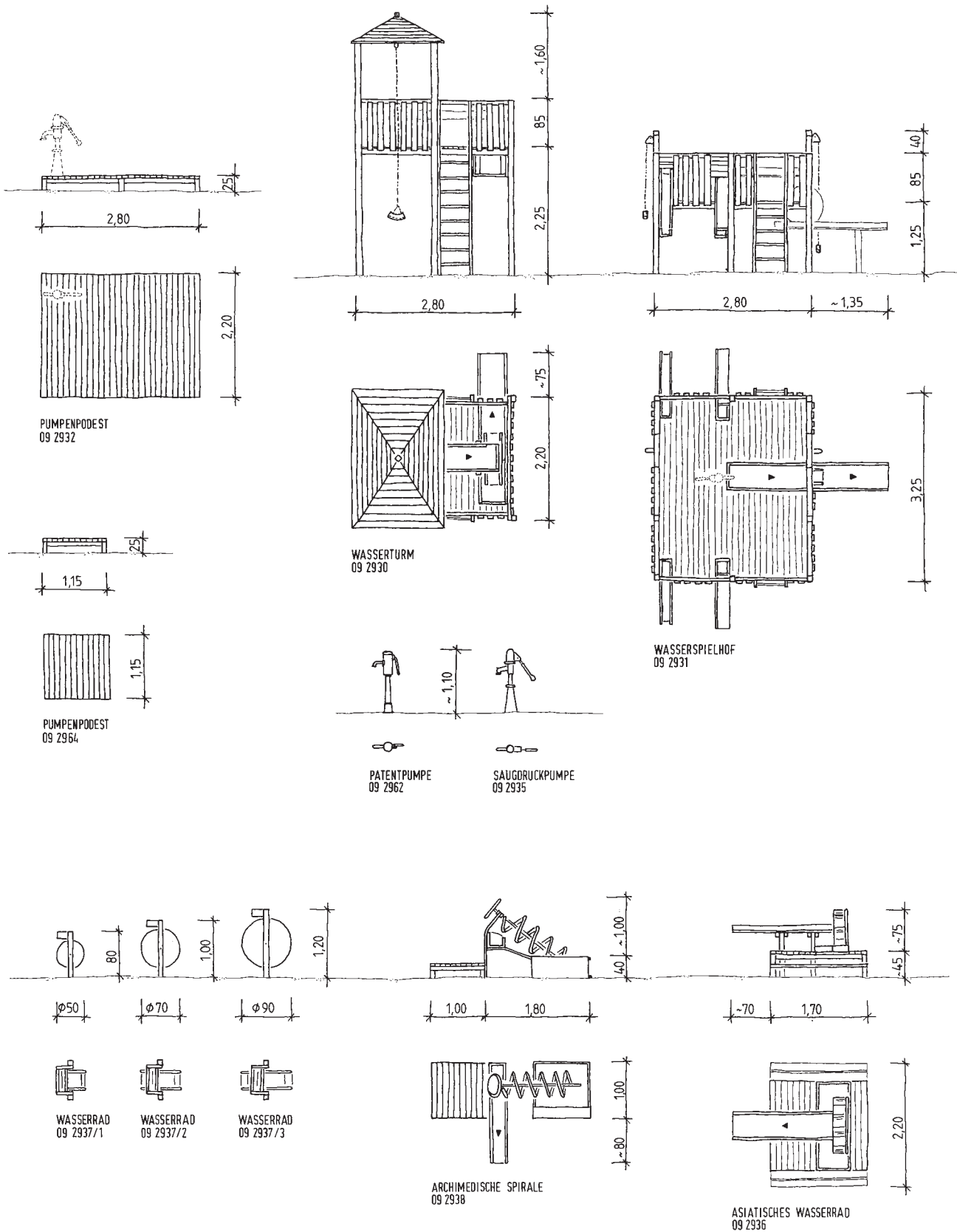

Jeux d'eau et de sable

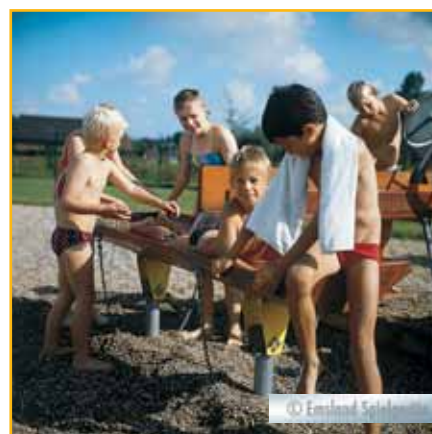

Jeux d'eau et de sable

Jeux d'eau et de sable

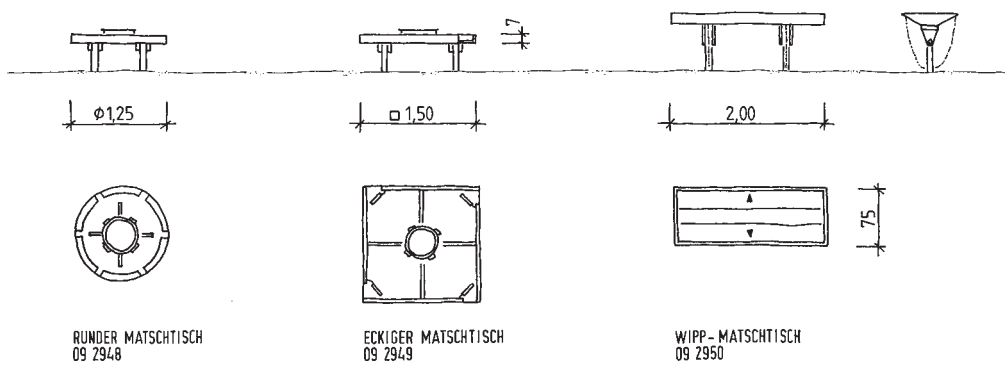
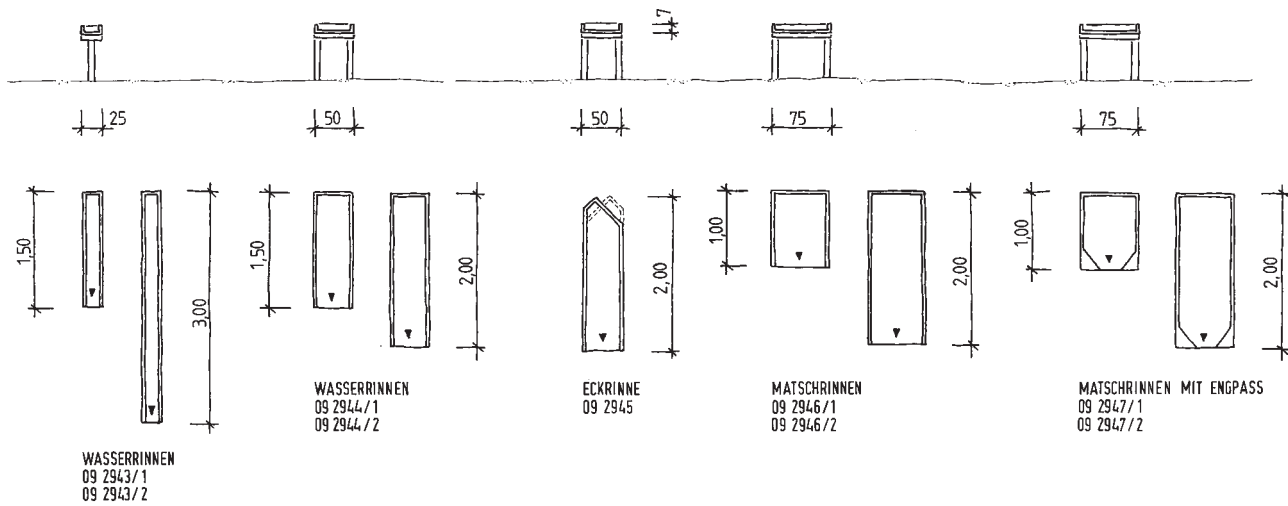
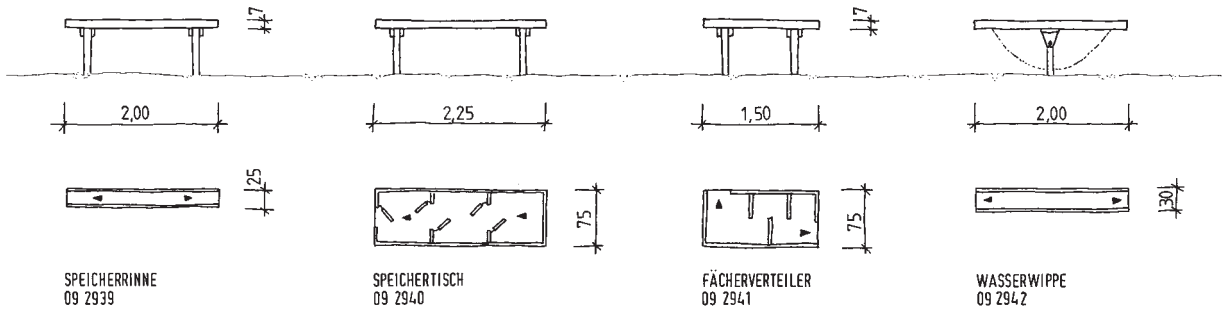



Table de jeux

Accessible pour les personnes à mobilité réduite



Jeux d'eau et de sable



Jeux d'eau et de sable



Jeux d'eau et de sable



Jeux d'eau et de sable

Kinderland
Emsland Spielgeräte



Référence 091659
Référence 091659/1



Jeux d'eau et de sable

Référence 091659V, E

Référence 091659/1V, E

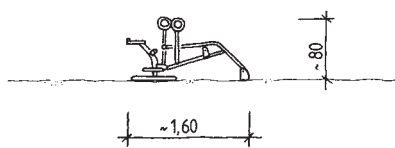

SPIELBAGGER 09 1659
SPIELBAGGER 09 1659/1

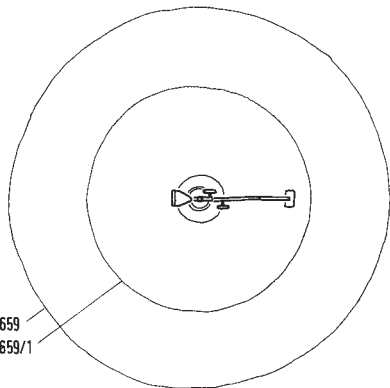

Jeux d'eau et de sable

Kinderland
Emsland Spielgeräte



Référence GAT 101000R

Référence 092840/2

Référence 092850

Jeux d'eau et de sable

Référence GAT 101000R

Référence 092840/2D

Référence 092850D

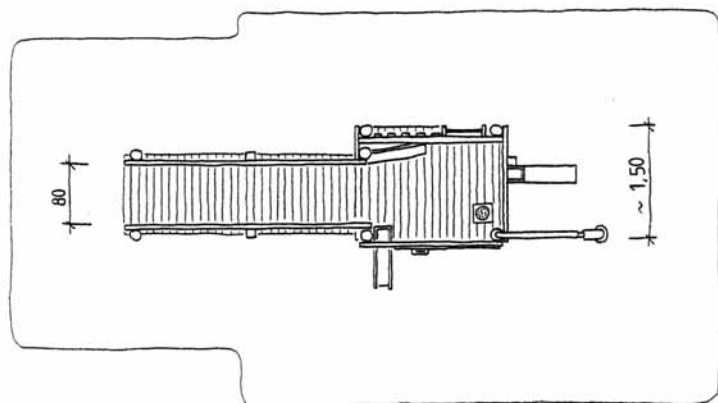
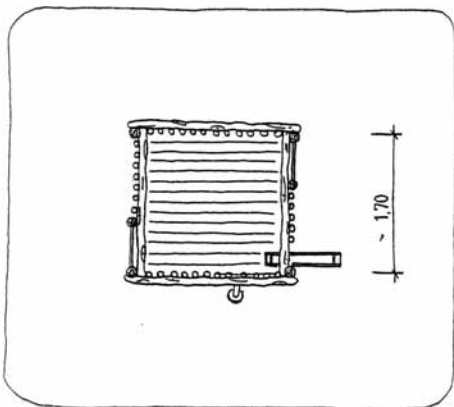
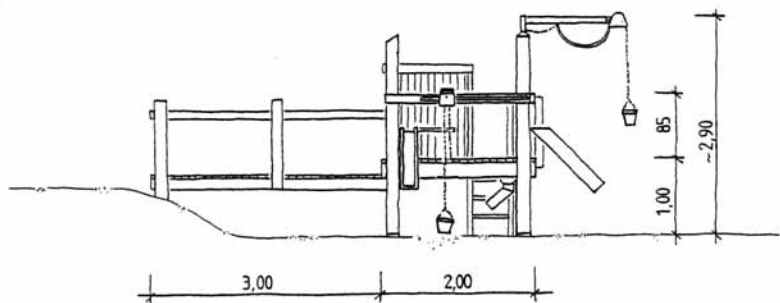
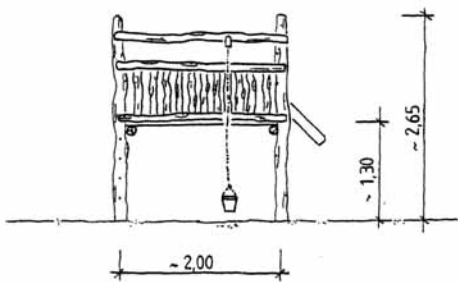

ROBINIEN- SANDSPIELHOF
GAT 101000 R

SANDSPIELHOF MIT BRÜCKE
092850 D

Jeux d'eau et de sable

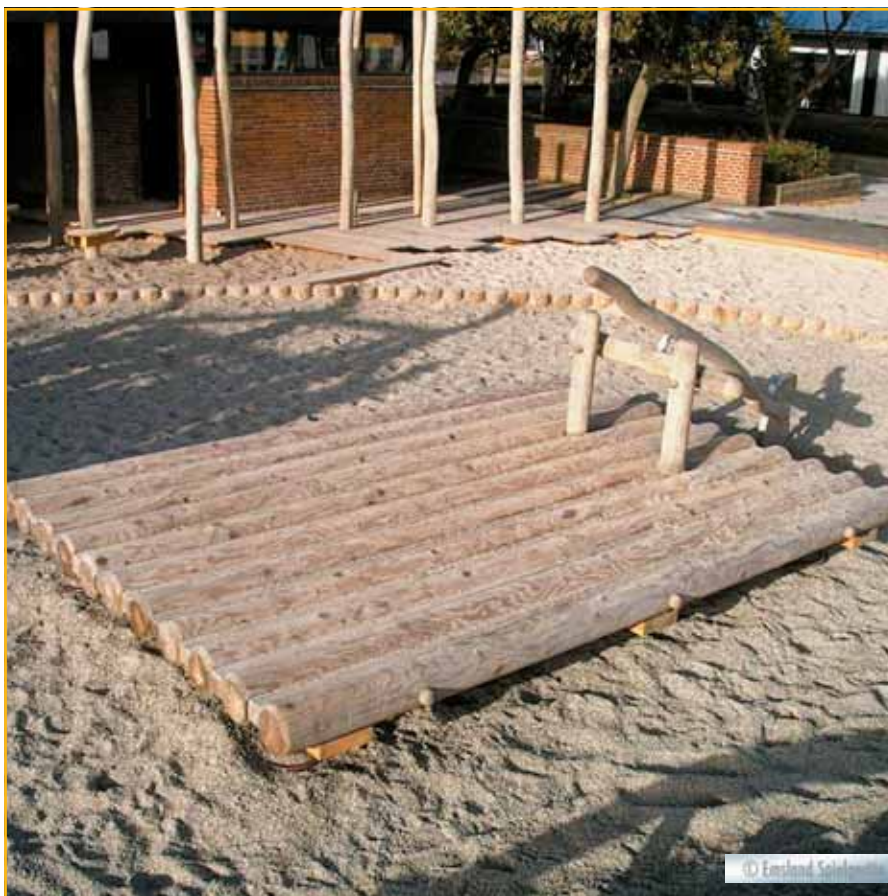

Référence 112000



Jeux d'eau et de sable

Référence 11200D, R

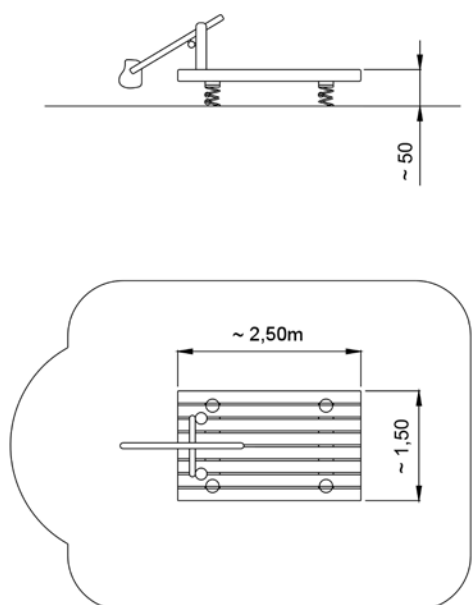



Kinderland
Emsland Spielgeräte

Jeux d'eau et de sable



Entourages pour aires de jeux
d'eau et de sable

Jeux d'eau et de sable

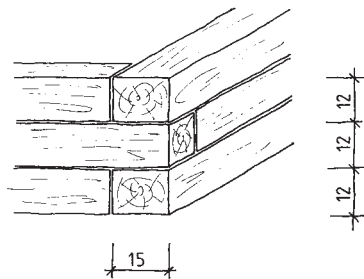

SANDKASTENEINFASSUNG
09 2705/1

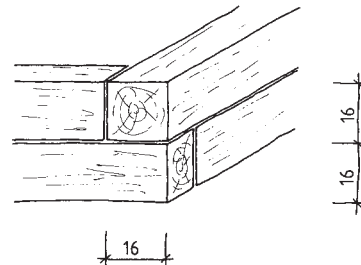

SANDKASTENEINFASSUNG
09 2705/2

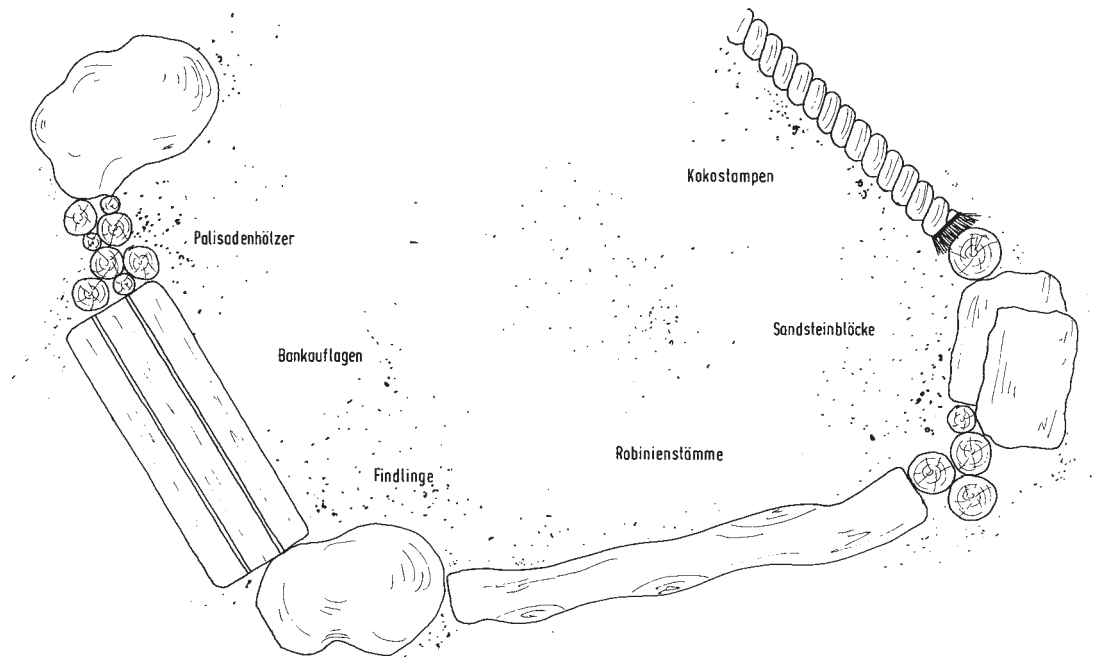

BEISPIEL FÜR SANDKASTENEINFASSUNGEN

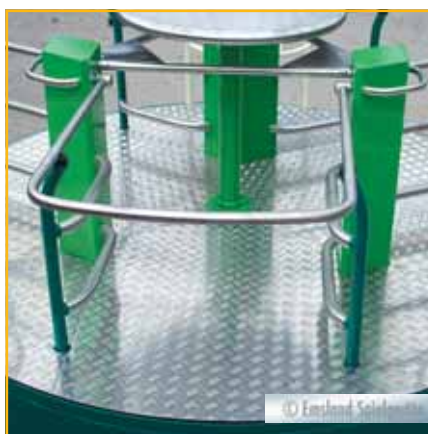

Tourniquets pour fauteuils roulants
Référence 121009L



Glissières, Carrousel, Jeux sur ressort, Balançoires à bascules

Référence 121009L

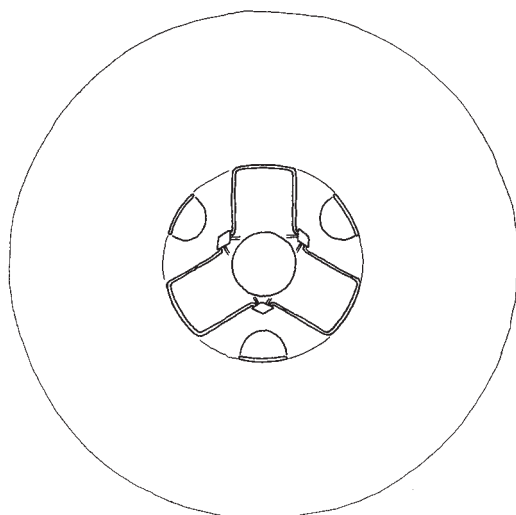
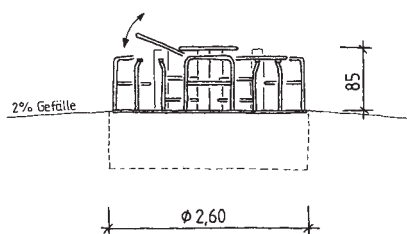



Balançoires pour fauteuils roulants

Référence 122931

Glissières, Carrousel, Jeux sur ressort, Balançoires à bascules

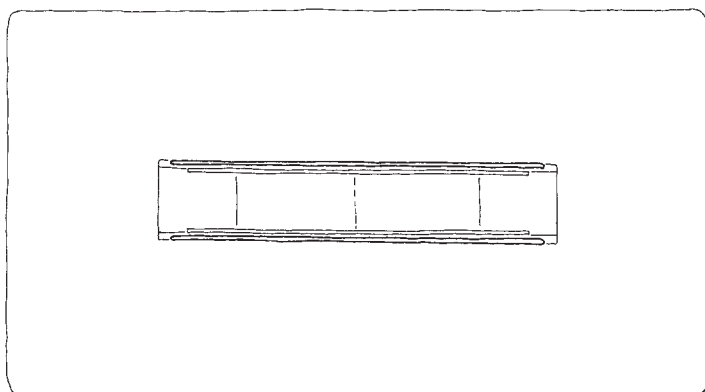
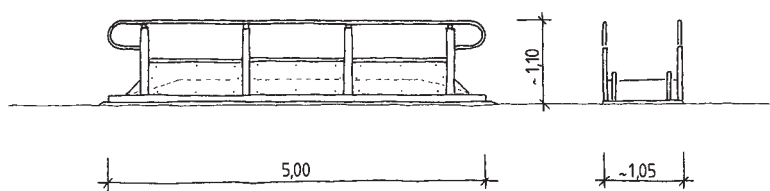

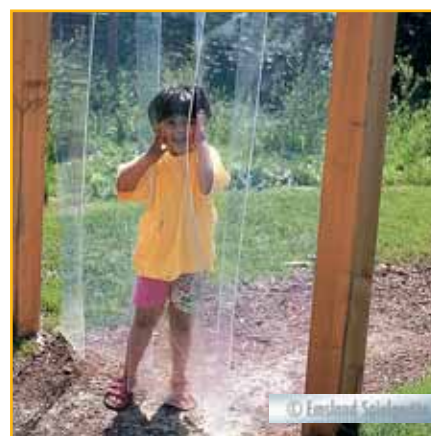

Portiques

Référence 113601-06



Glissières, Carrousel, Jeux sur ressort, Balançoires à bascules

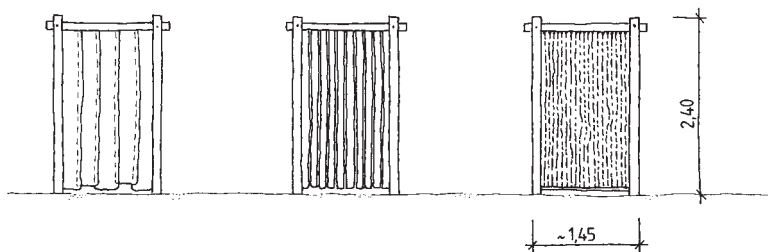

Klarsichtbänder
11 3601

Gummimatten
11 3602

Ketten
11 3603

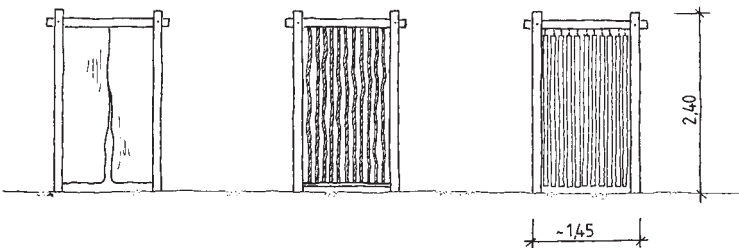

Markisenvorhänge
11 3604

Herkulesseile
11 3605

Kunststoffrohre
11 3606

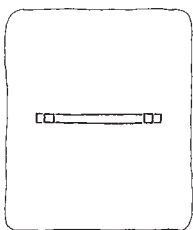

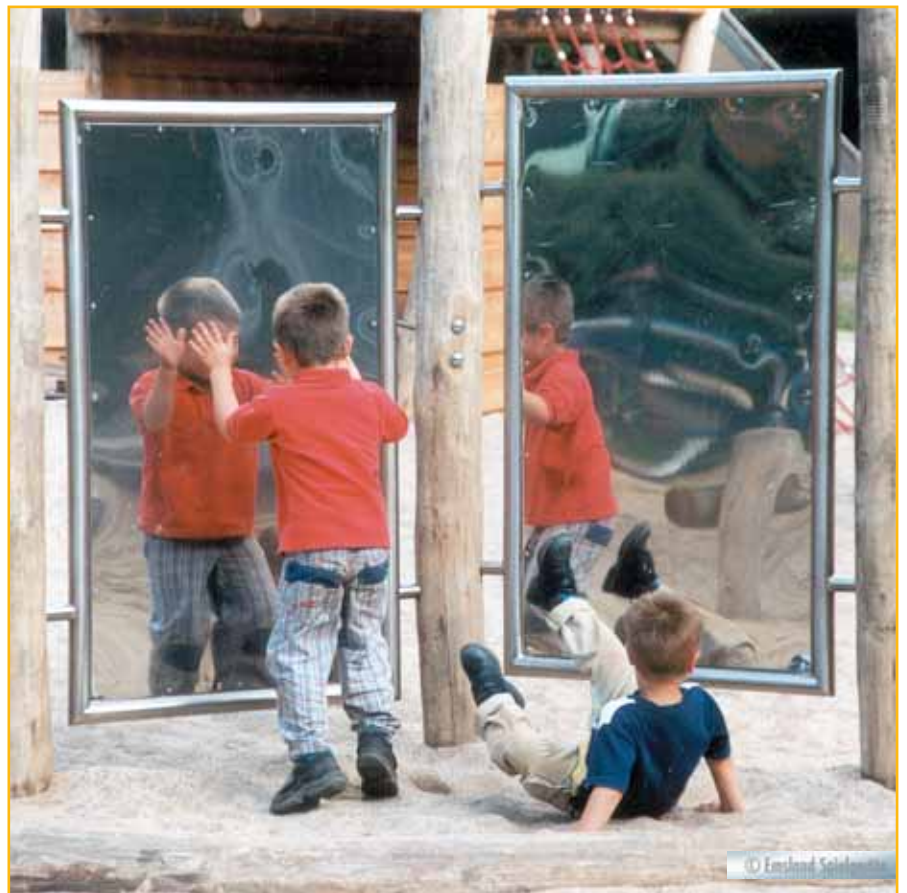

Référence 113310-15

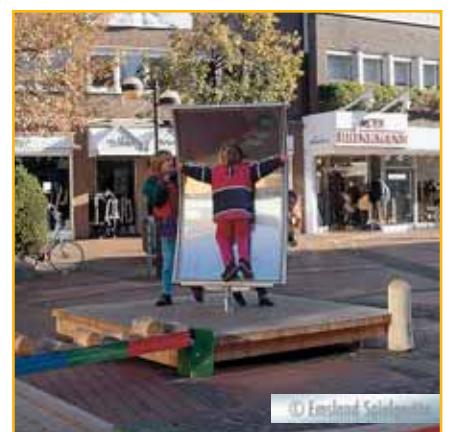

Glissières, Carrousel, Jeux sur ressort, Balançoires à bascules

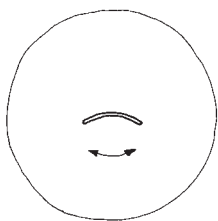
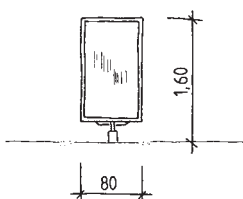

drehbar / gebogen
11 3310

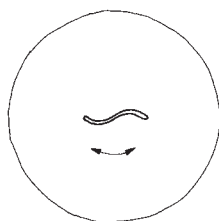
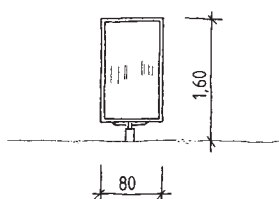

drehbar / gewellt
11 3311

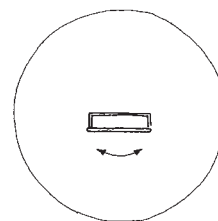
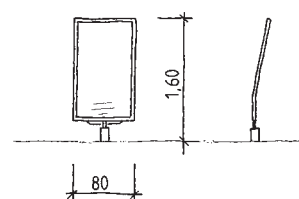

drehbar / geneigt
11 3312

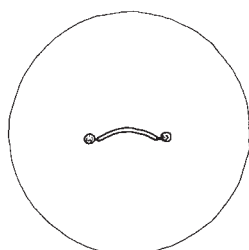
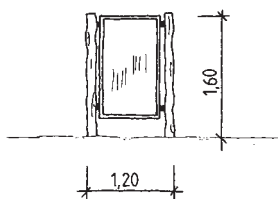

gebogen
11 3313

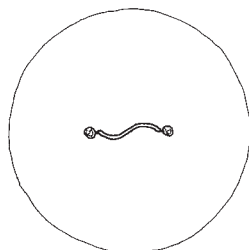
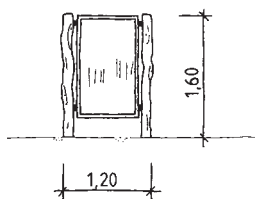

gewellt
11 3314

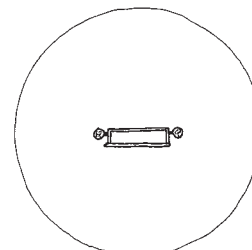
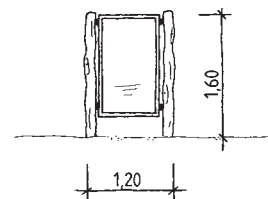

geneigt
11 3315



Glissière tubulaire

Glissières, Carrousel, Jeux sur ressort, Balançoires à bascules

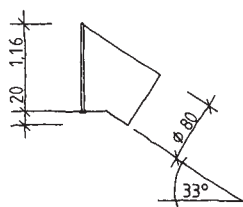

Einstieg
03 1141

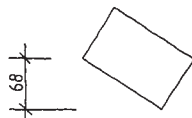

Gerade
03 1142

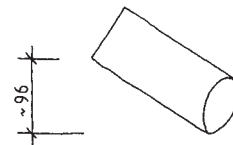
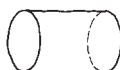

Kurve 30° rechts
03 1147

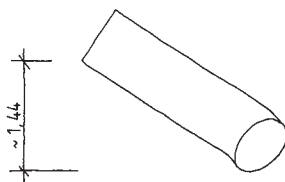

Kurve 45° rechts
03 1148

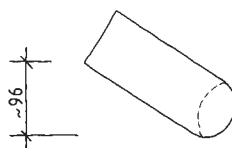

Kurve 30° links
03 1149

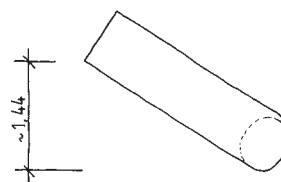

Kurve 45° links
03 1150

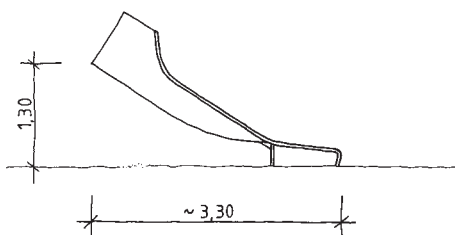

Ausstieg
03 1144

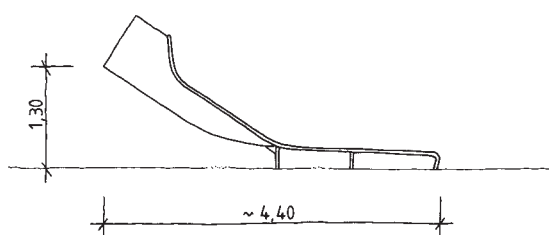

Ausstieg verlängert
03 1145





Glissière en Y

Référence 031190



Glissières, Carrousel, Jeux sur ressort, Balançoires à bascules

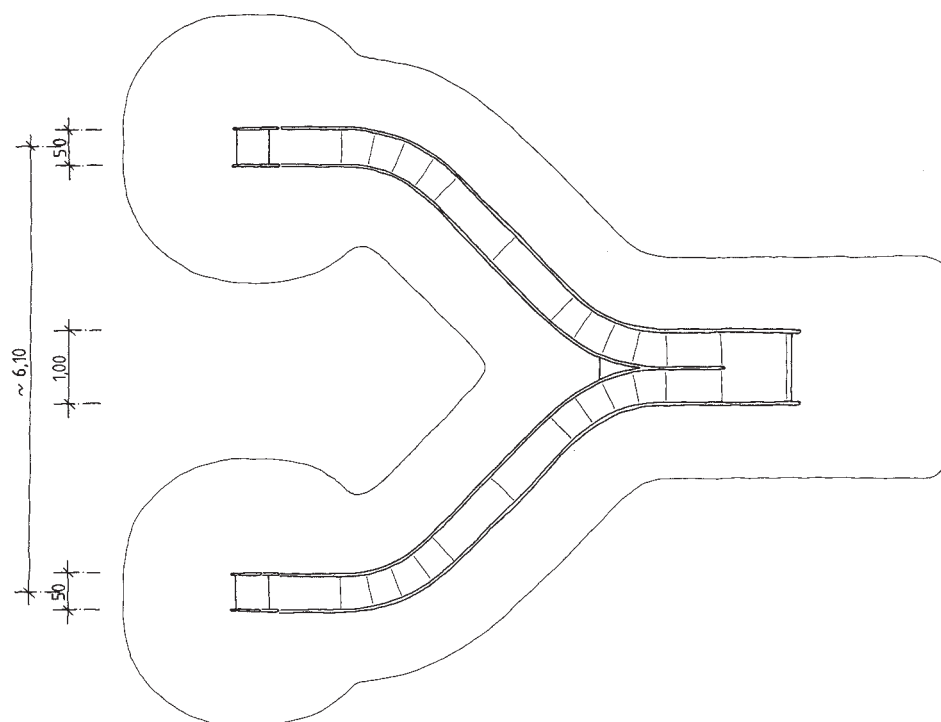
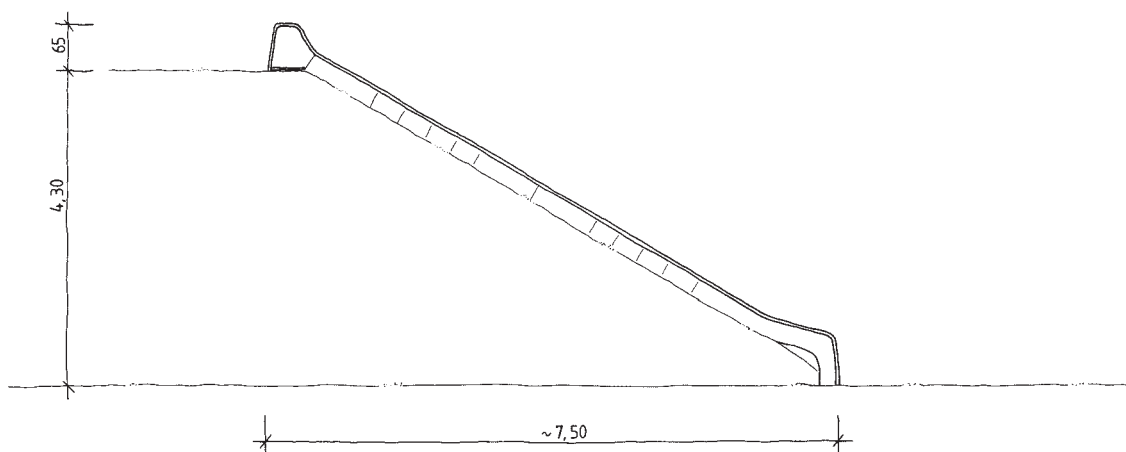



Glisière berceau



Glissières, Carrousel, Jeux sur ressort, Balançoires à bascules

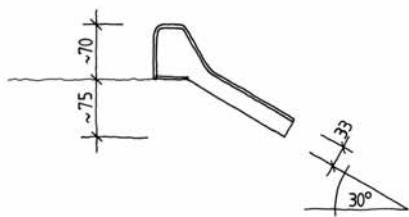

Einstieg
03 1110

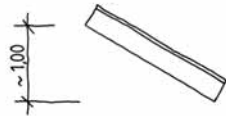

Gerade
03 1113



Kurve 30°-rechts
03 1115

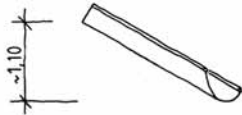

Kurve 45°-rechts
03 1112



Kurve 30°-links
03 1114



Kurve 45°-links
03 1111

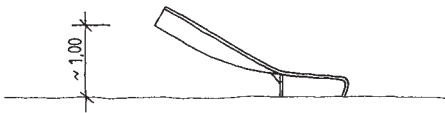

Ausstieg
03 1116

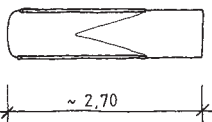

Ausstieg verlängert
03 1117

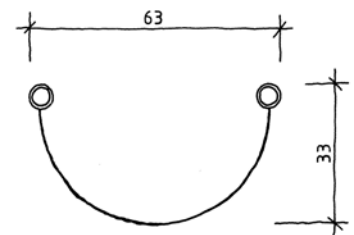
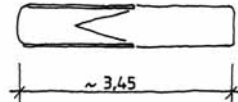

Schalenschnitt
M 1 : 20



Référence 031180E



Glissières, Carrousel, Jeux sur ressort, Balançoires à bascules

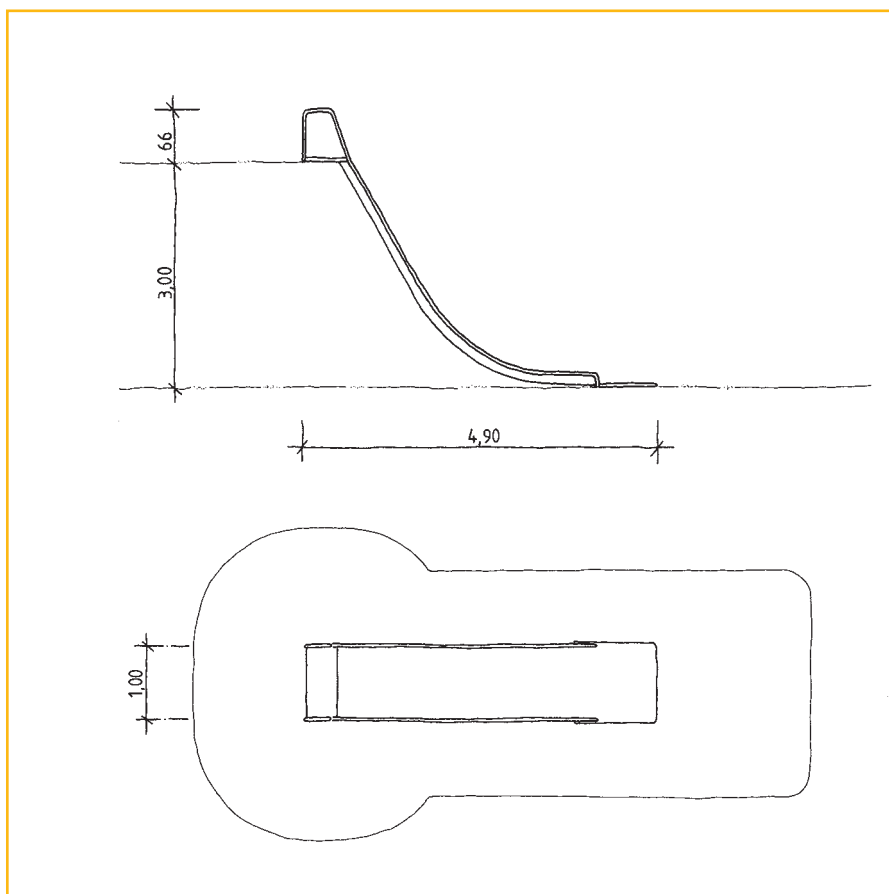



Glisière de butte



Glissières, Carrousel, Jeux sur ressort, Balançoires à bascules

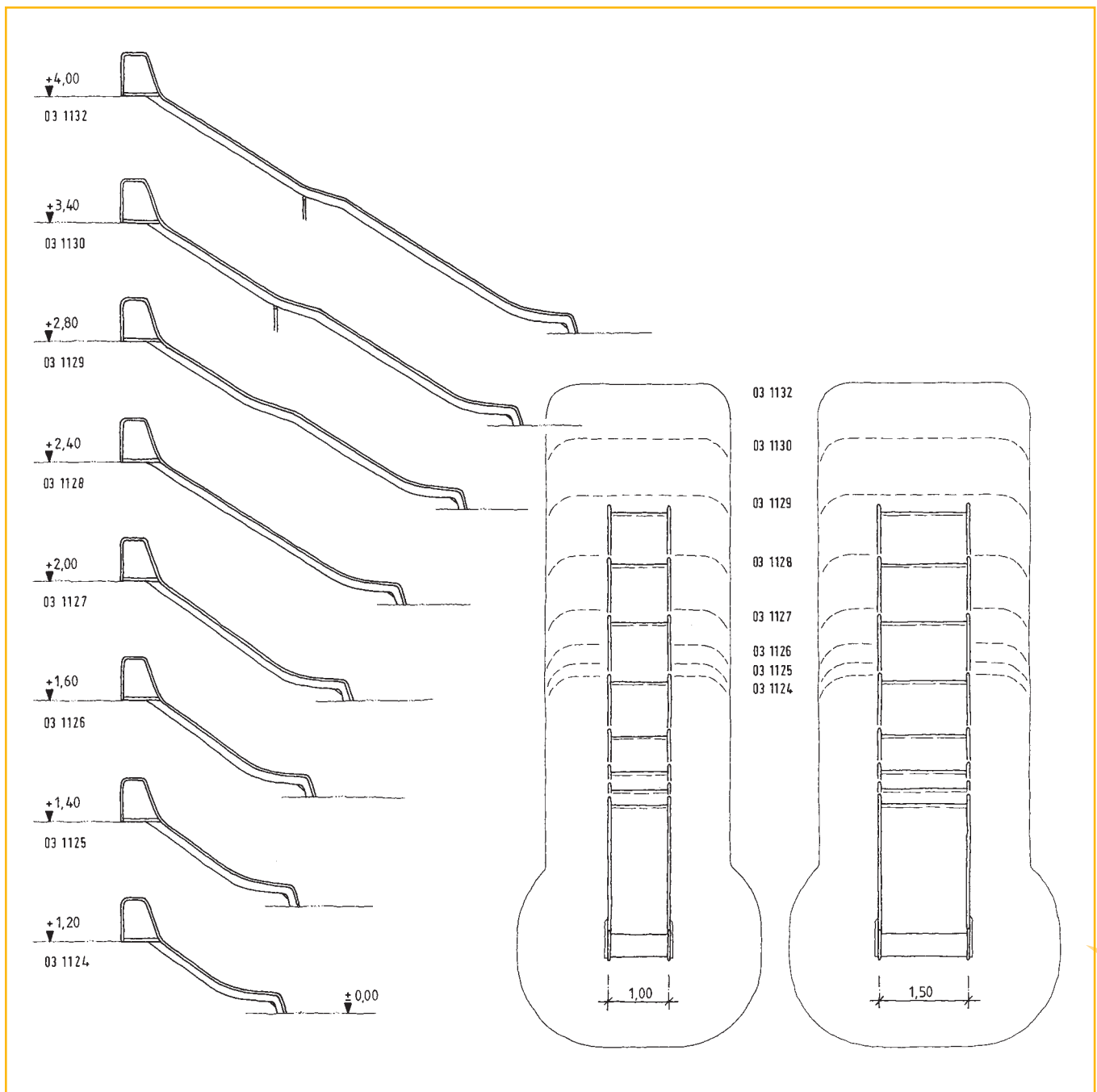



Glissières, Carrousel, Jeux sur ressort, Balançoires à bascules

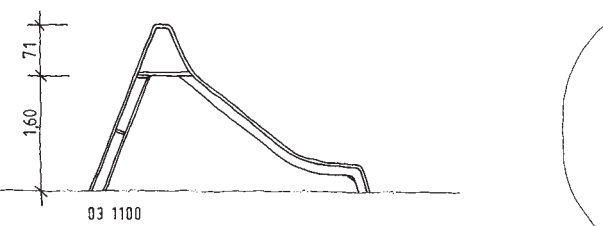
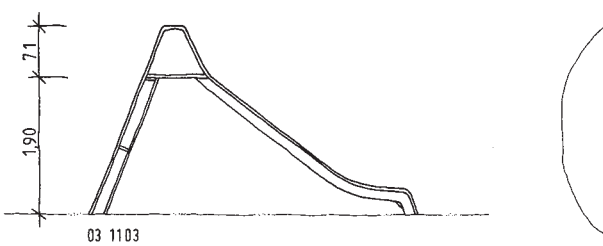
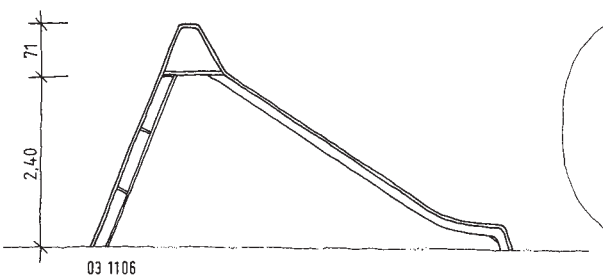
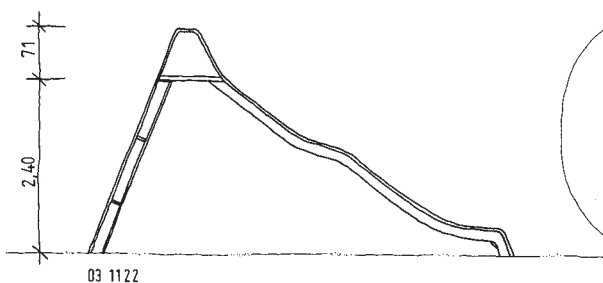



Référence GAT 112003E

Glissières, Carrousel, Jeux sur ressort, Balançoires à bascules

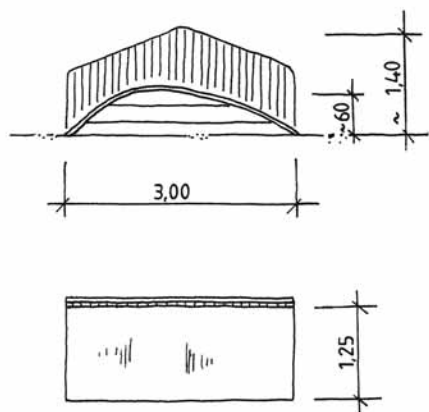

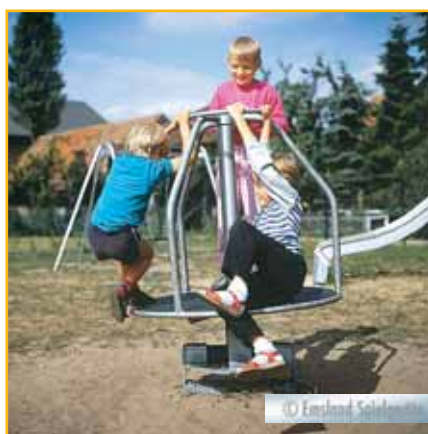
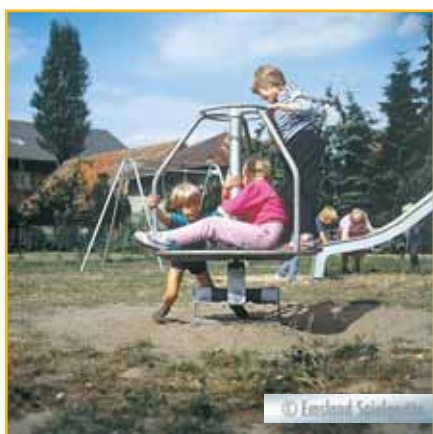

Tourniquets et jeux oscillants

Référence 051007/1

Référence 051007/2

Référence 058030

Glissières, Carrousel, Jeux sur ressort, Balançoires à bascules

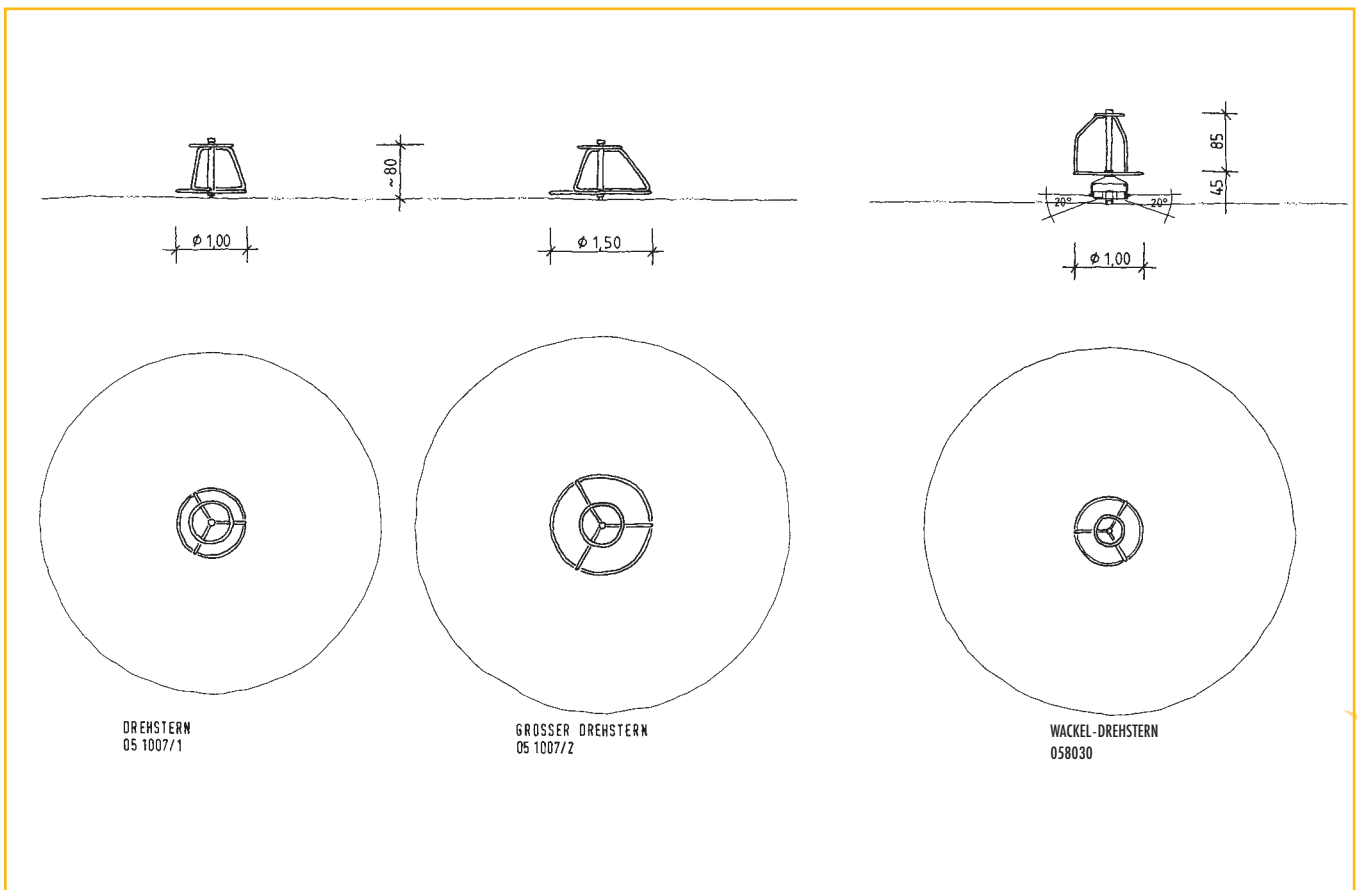



Référence 051000

Glissières, Carrousels, Jeux sur ressort, Balançoires à bascules

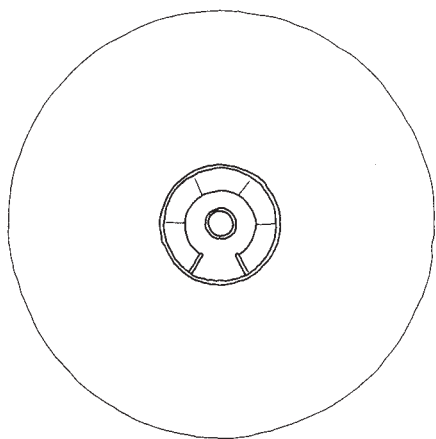
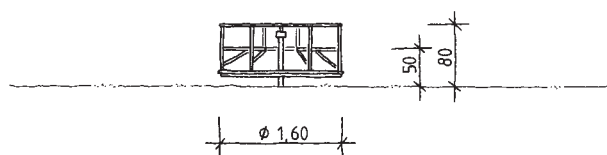



Référence 051005

Glissières, Carrousel, Jeux sur ressort, Balançoires à bascules

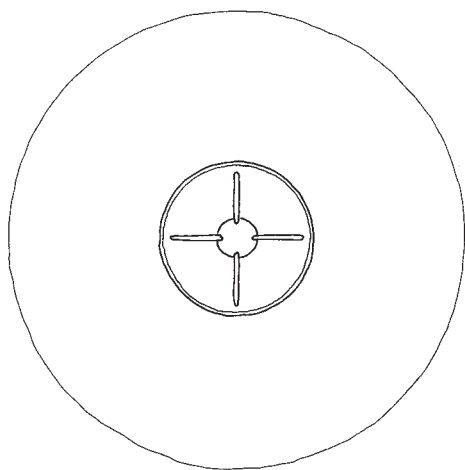
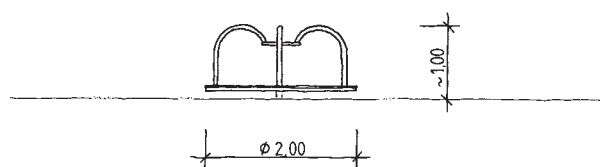

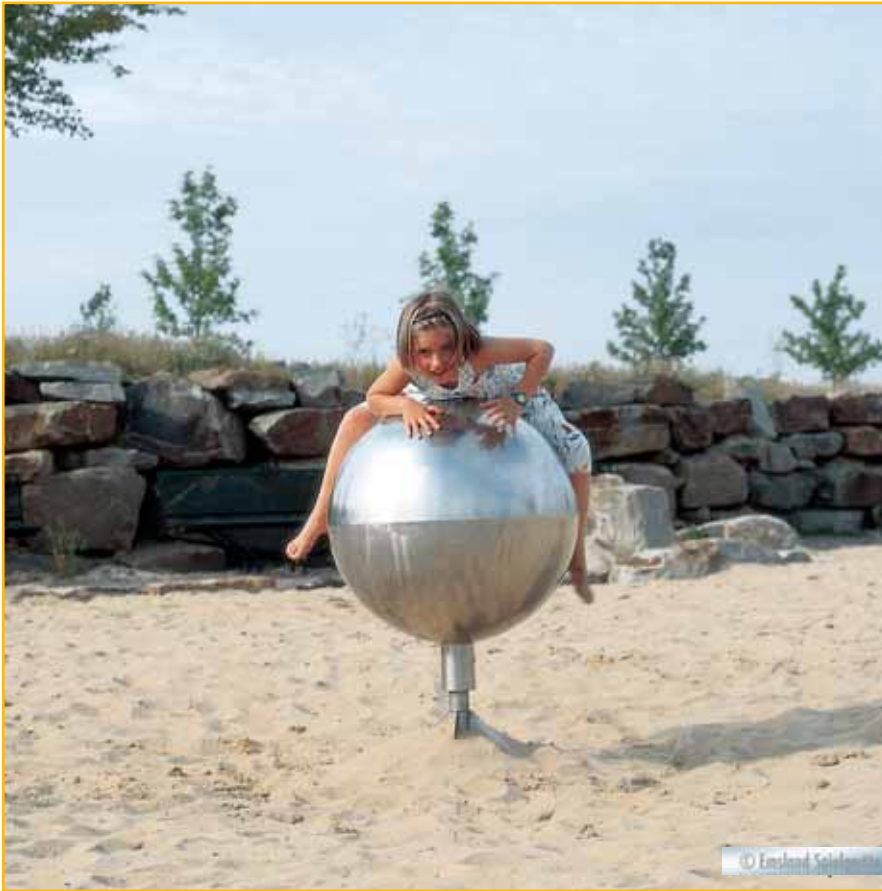

Référence 052700E

Glissières, Carrousel, Jeux sur ressort, Balançoires à bascules

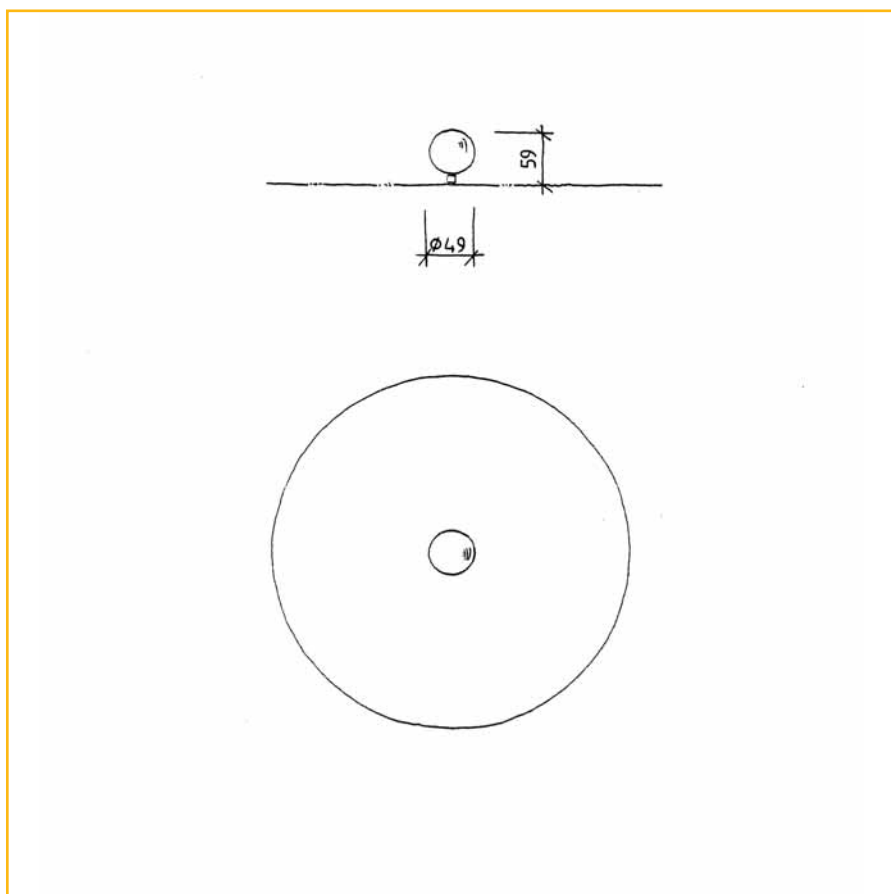



Jeux sur ressort Tulipe

Référence 078026E

Glissières, Carrousel, Jeux sur ressort, Balançoires à bascules

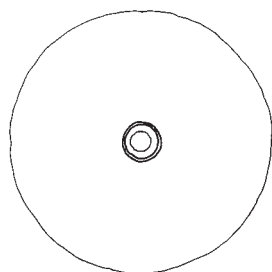
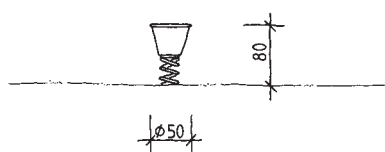

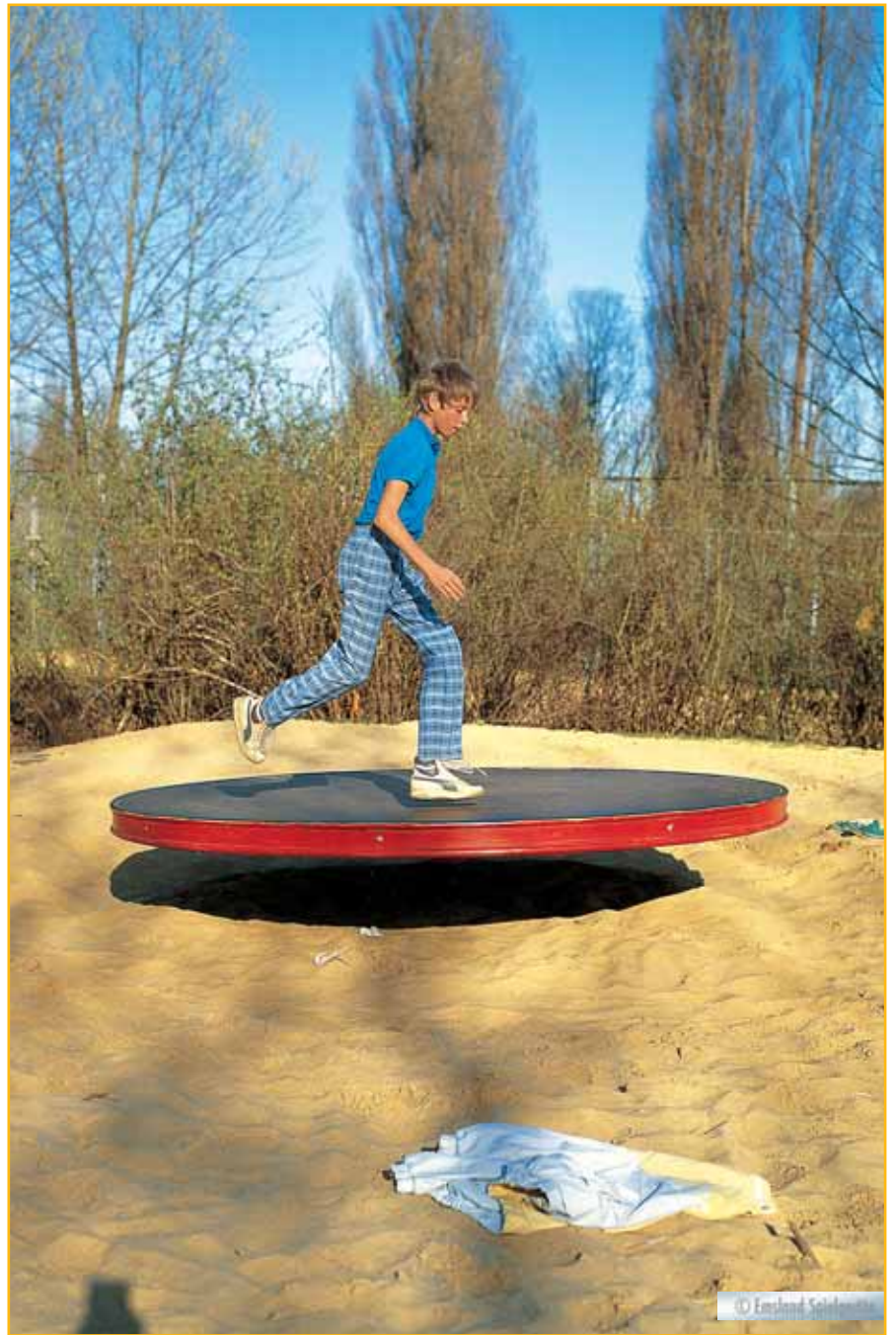

Soucoupe

Référence 050990

Référence 050992

Glissières, Carrousel, Jeux sur ressort, Balançoires à bascules

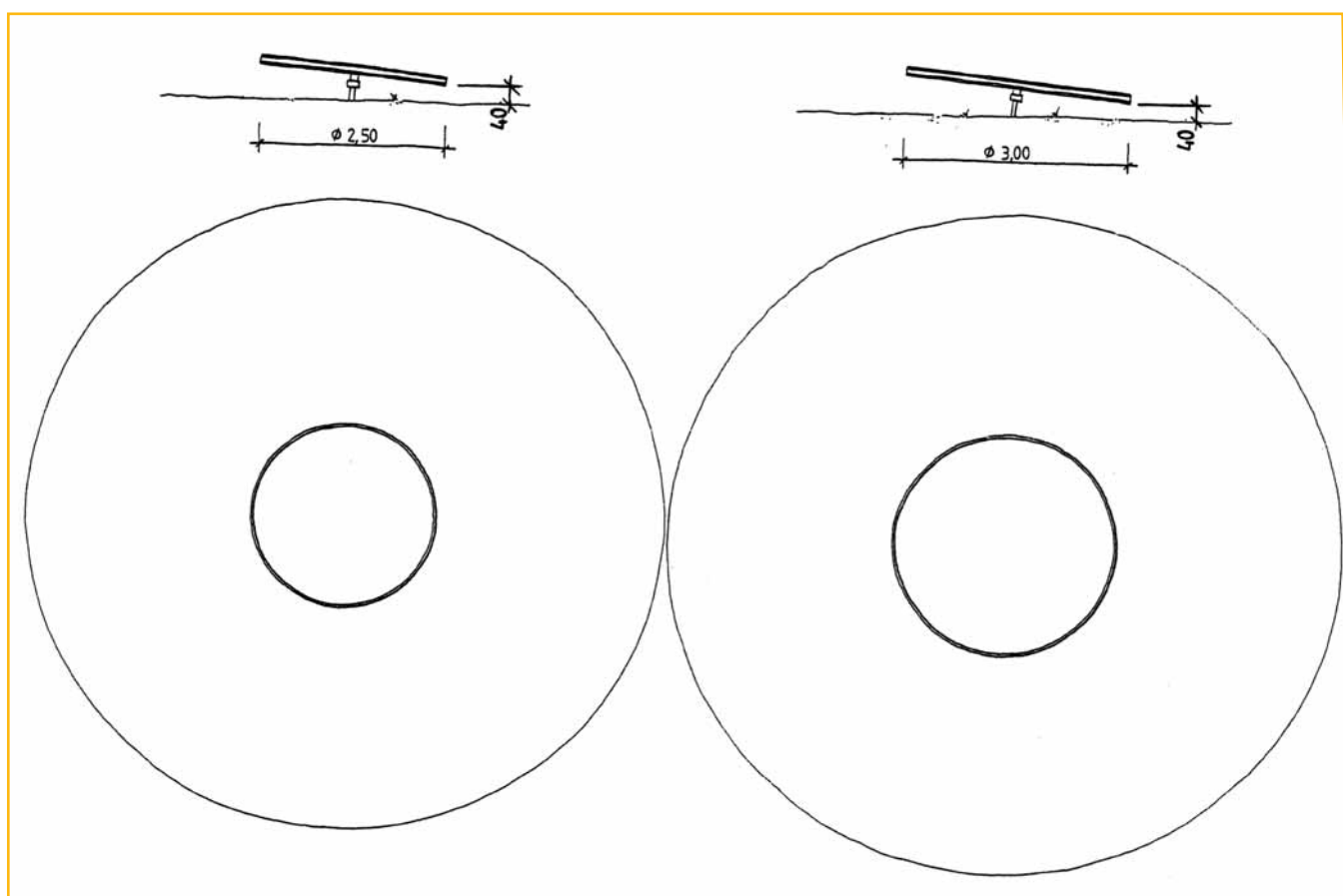



Balançoire à bascule



Glissières, Carrousel, Jeux sur ressort, Balançoires à bascules

Artikel-Nr. 061054L, V, VL

Artikel-Nr. 063064V, VL

Artikel-Nr. 068040V, VL

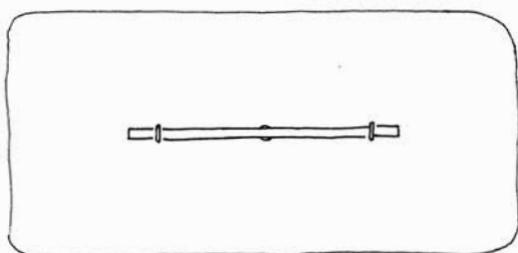
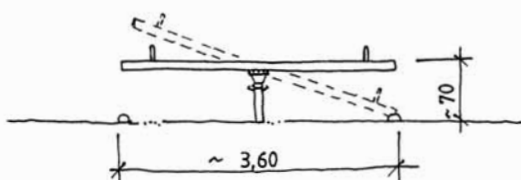

Balkenwipper 068040

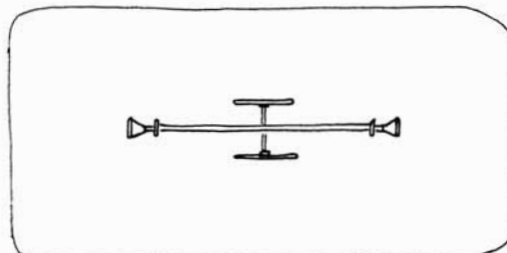
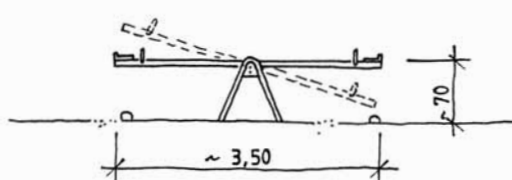

Stahlrohrwippe 061054

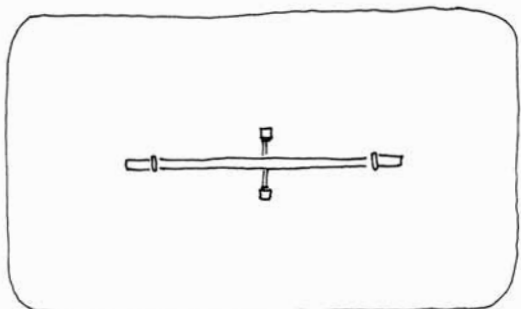

Balkenwippe 063064



Référence 021056VL

Glissières, Carrousel, Jeux sur ressort, Balançoires à bascules

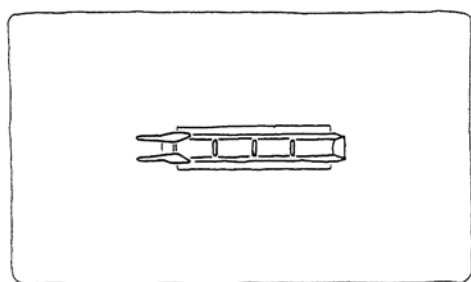
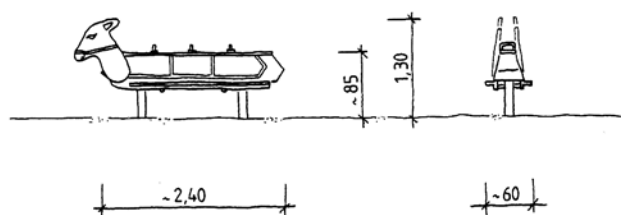



Kinderland
Emsland Spielgeräte

Jeux de grimpe et d'équilibre



Jeux de grimpe et d'équilibre

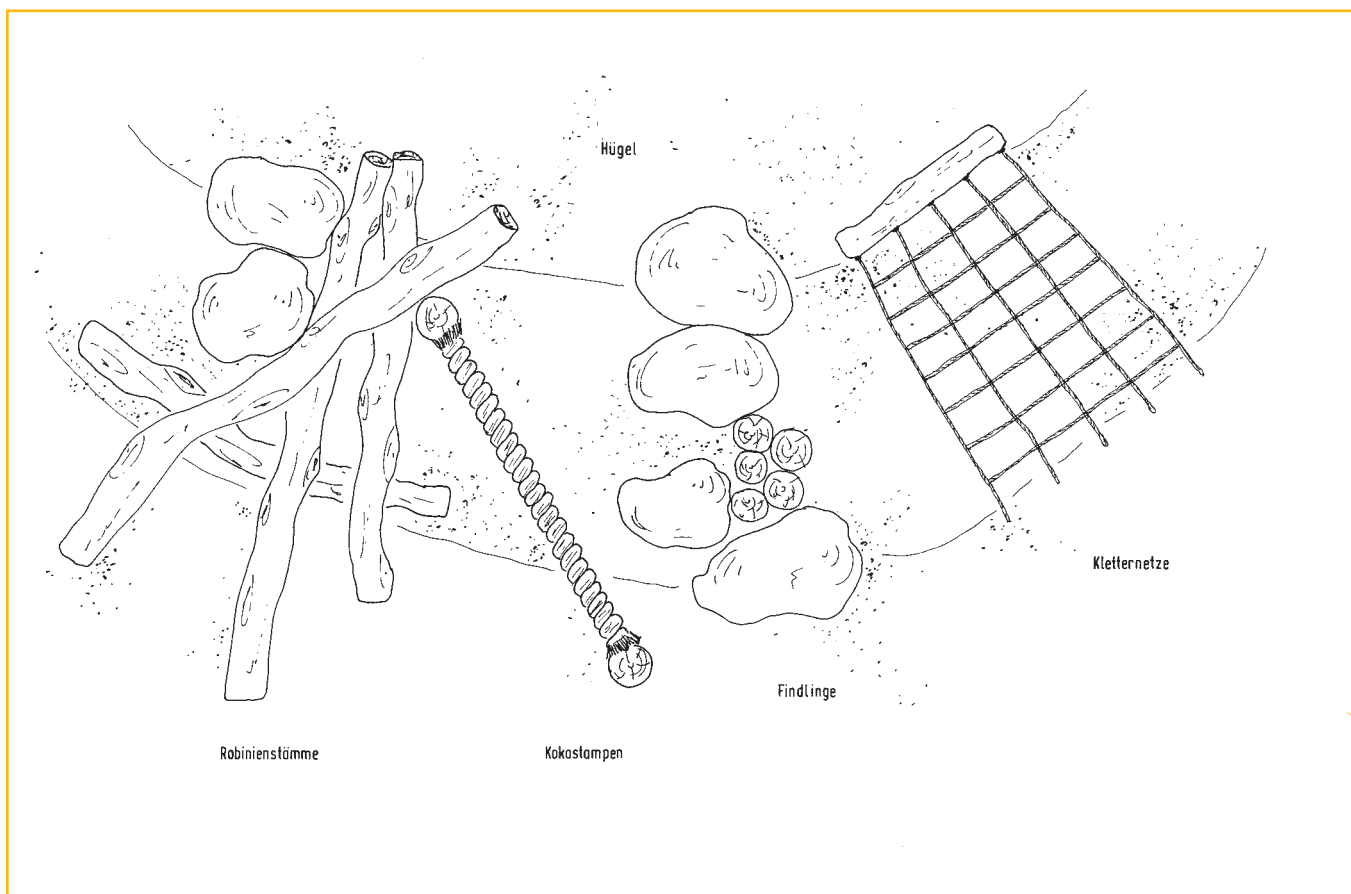

Jeux de grimpe et d'équilibre



Référence 022778

Référence 072768

Jeux de grimpe et d'équilibre

Référence 072778D,R

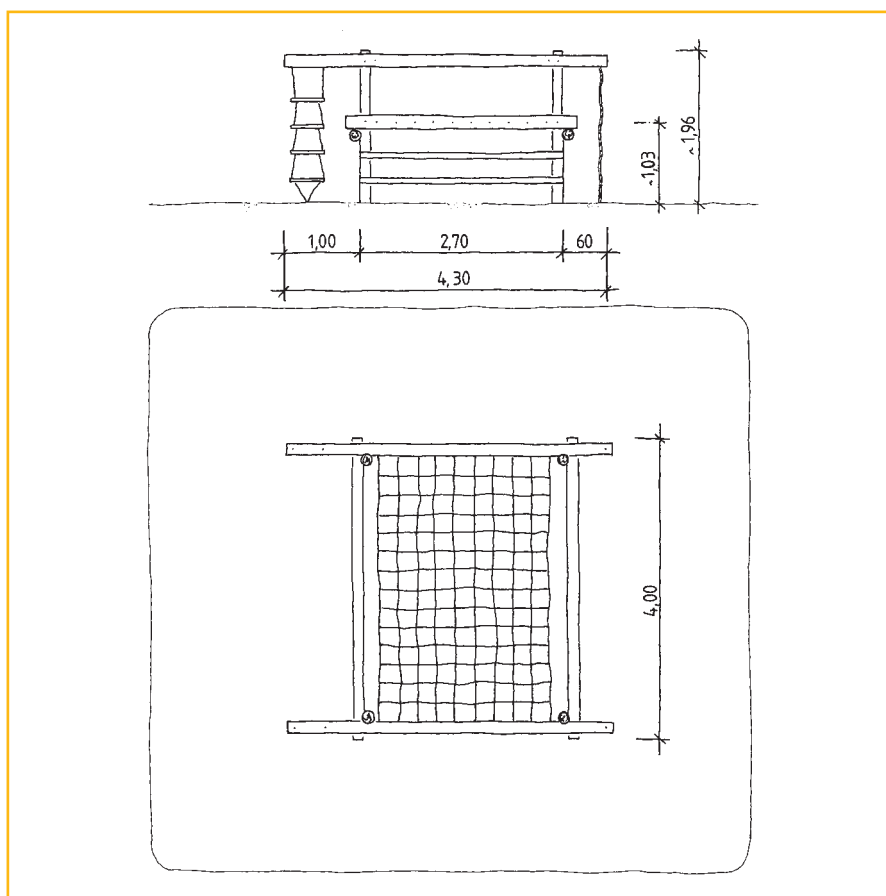

Référence 072768V, VL

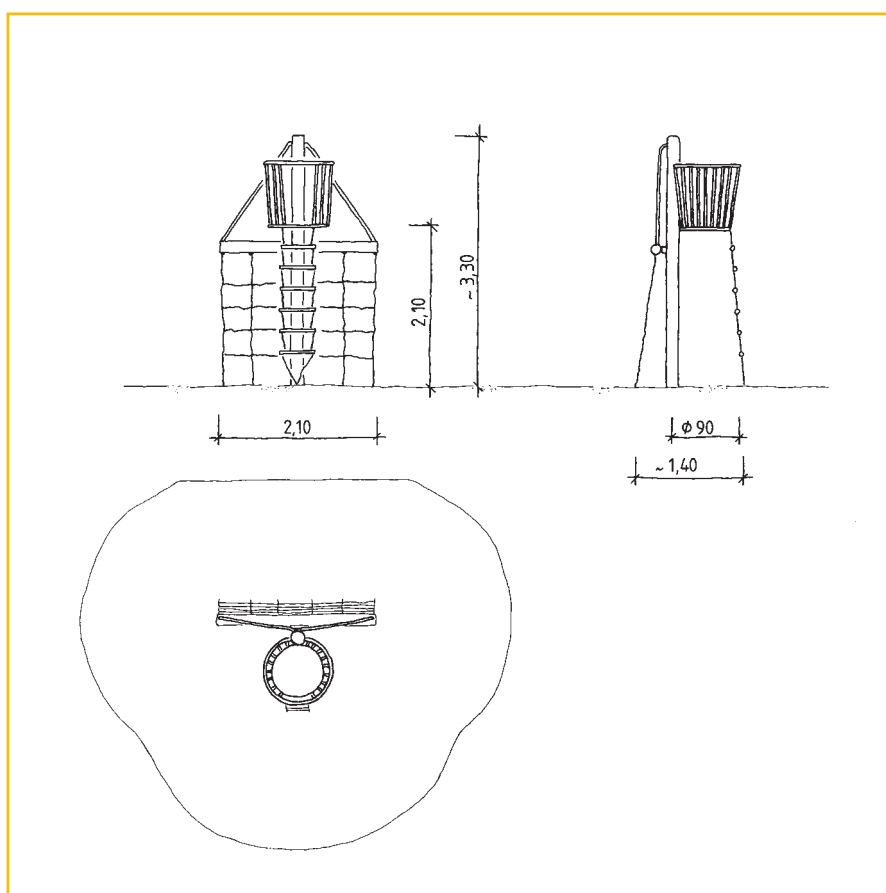

Jeux de grimpe et d'équilibre



Référence 072776/1



Jeux de grimpe et d'équilibre

Référence 072776/1D,R

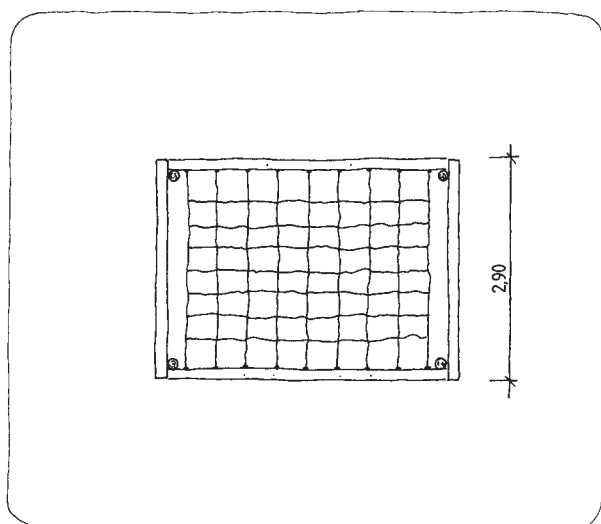
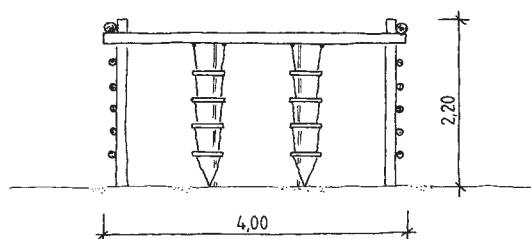

Jeux de grimpe et d'équilibre



Référence 071900R

Jeux de grimpe et d'équilibre

Référence 071900R

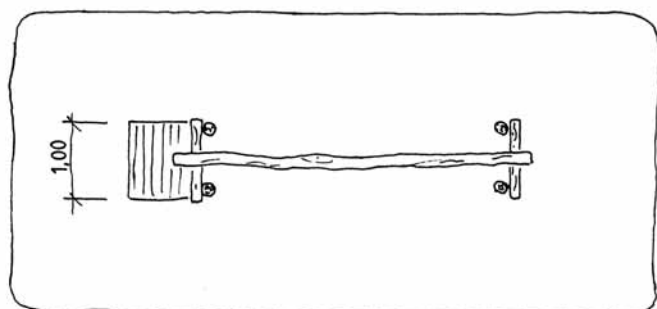
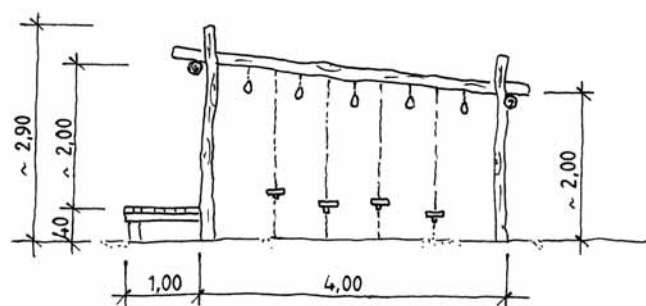

Jeux de grimpe et d'équilibre



Référence 072777



Jeux de grimpe et d'équilibre

Référence 072777D, R

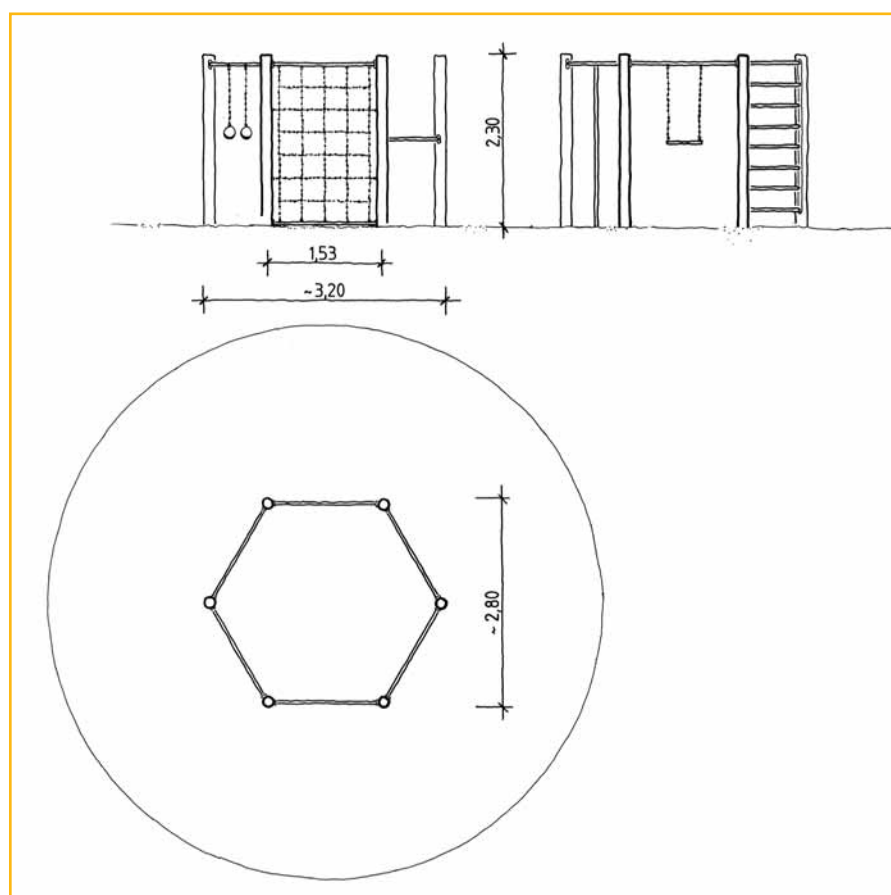



Kinderland
Emsland Spielgeräte

Jeux de grimpe et d'équilibre



Référence 073040/1-2

Référence 073030/1-2

Référence 071407/1-2

Jeux de grimpe et d'équilibre

Référence 073040/1-2R

Référence 073030/1-2D

Référence 071407/1-2L, V, VL

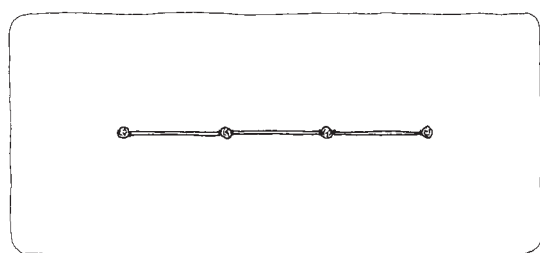
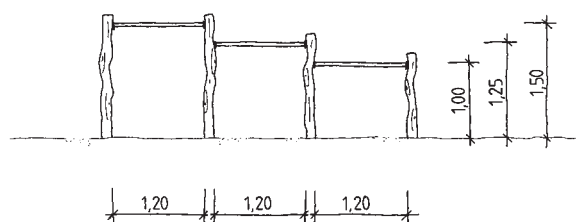

Variante Robinie
07 304.0

Jeux de grimpe et d'équilibre

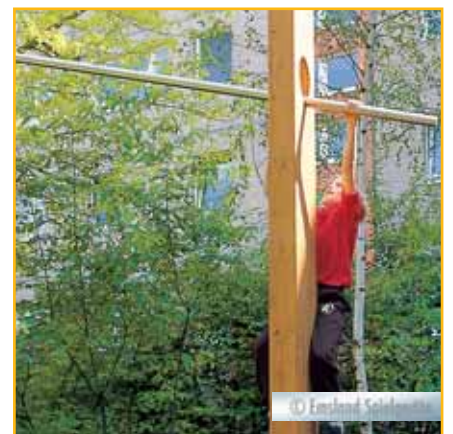

Référence GAT 130400T



Jeux de grimpe et d'équilibre

Référence GAT 130400T

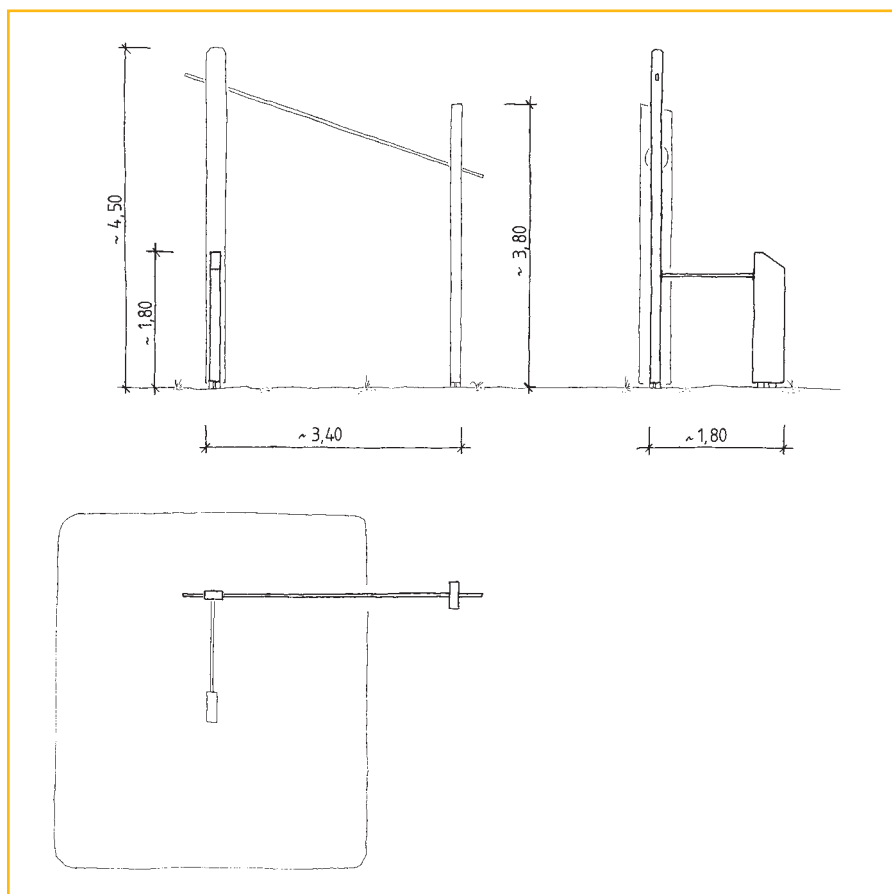



Kinderland
Emsland Spielgeräte

Jeux de grimpe et d'équilibre



Référence 078025

Référence 071510

Référence 114010R

Jeux de grimpe et d'équilibre

Référence 078025D

Référence 071510D

Référence 114010R

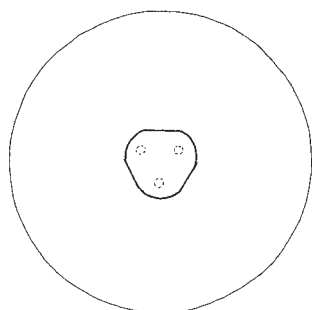
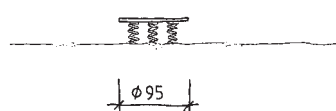

HÜPFPLATTE
07 8025

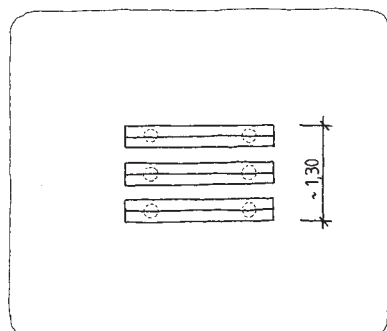
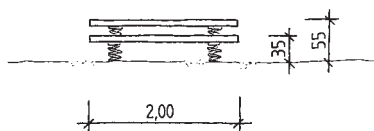

FEDERTREPPE
07 1510

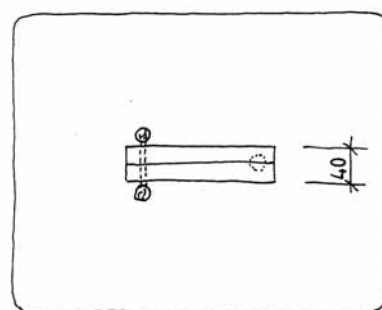
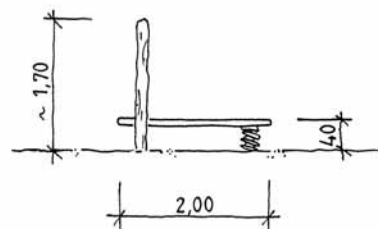

SPRUNGBRETT
114010R

Jeux de grimpe et d'équilibre



Jeux de grimpe et d'équilibre





Kinderland
Emsland Spielgeräte

Jeux de grimpe et d'équilibre

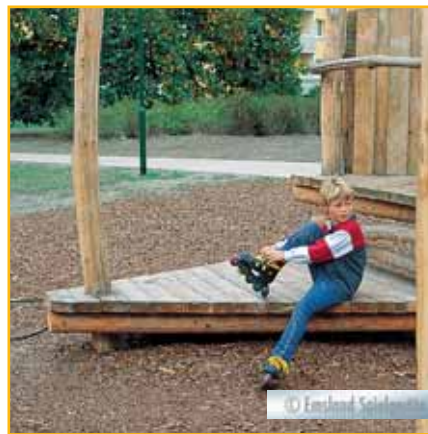

Référence GAT 003500R

Jeux de grimpe et d'équilibre

Référence GAT 003500R

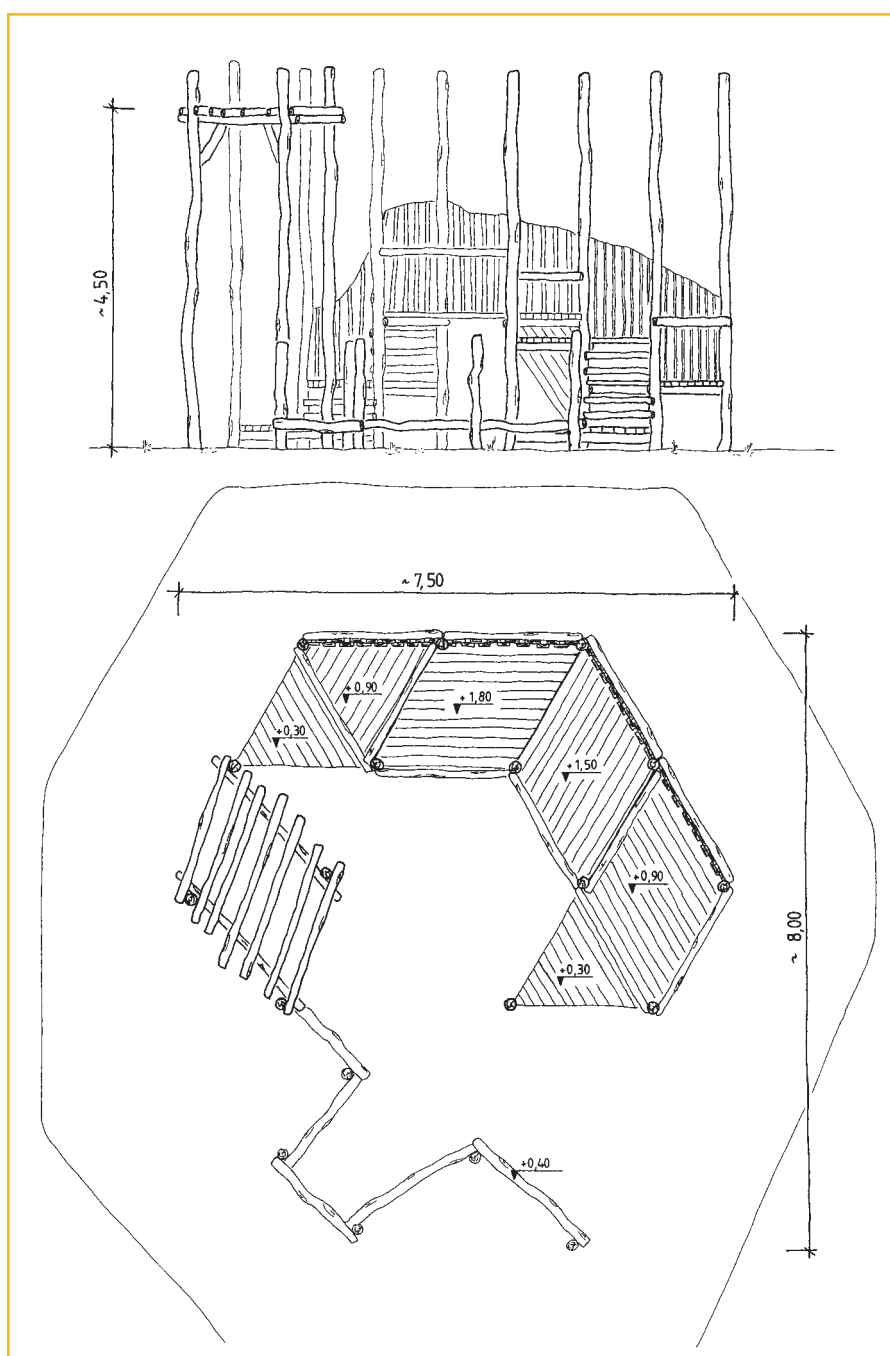



Kinderland
Emsland Spielgeräte

Jeux de grimpe et d'équilibre



Référence GAT 030500R



Jeux de grimpe et d'équilibre

Référence GAT 030500R

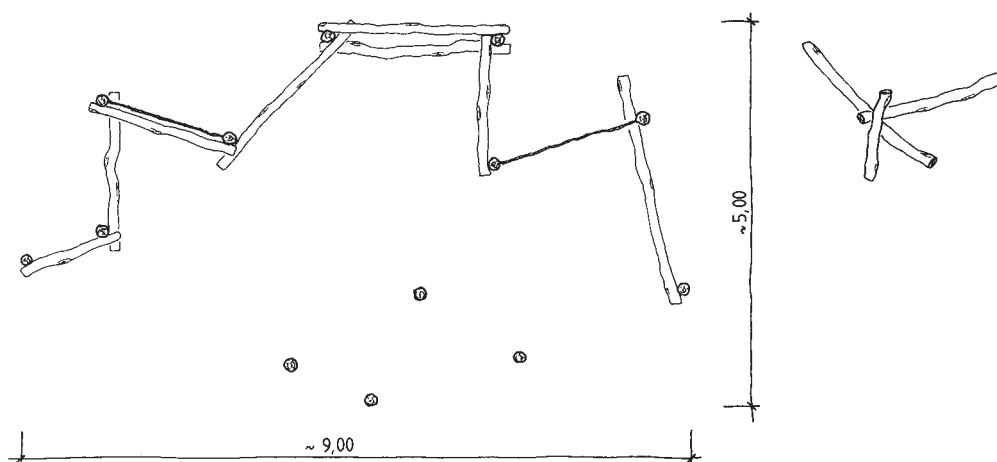
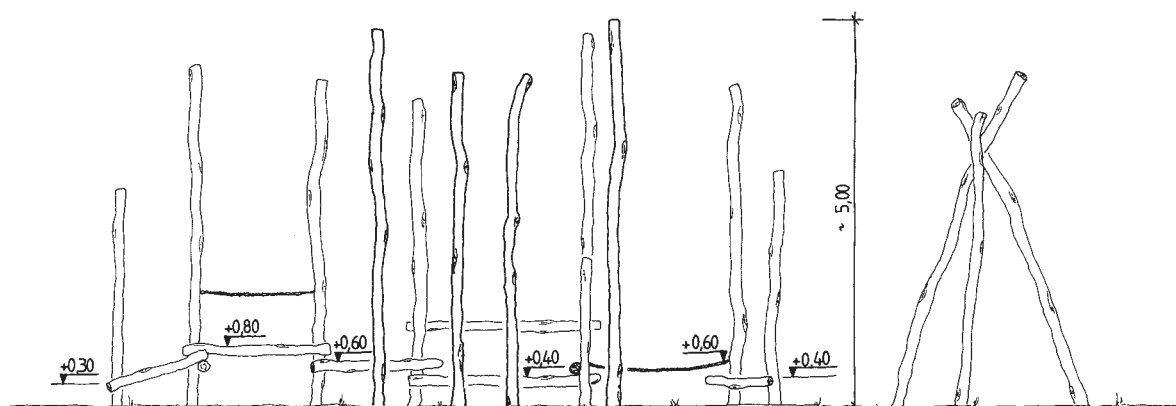

Jeux de grimpe et d'équilibre



Référence GAT 040700R



Jeux de grimpe et d'équilibre

Référence GAT 040700R

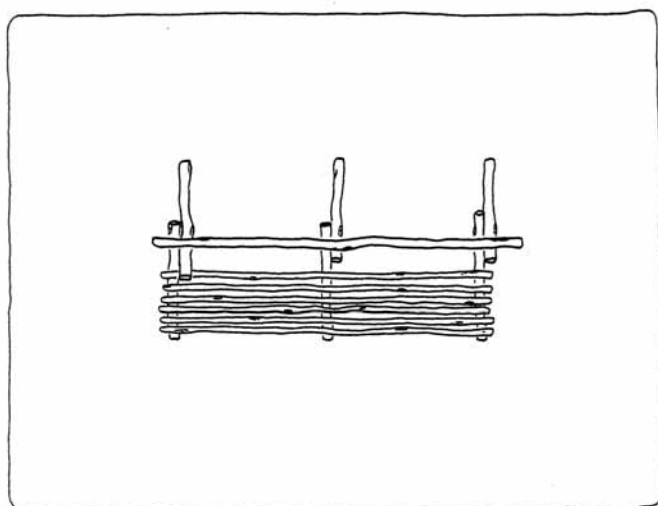
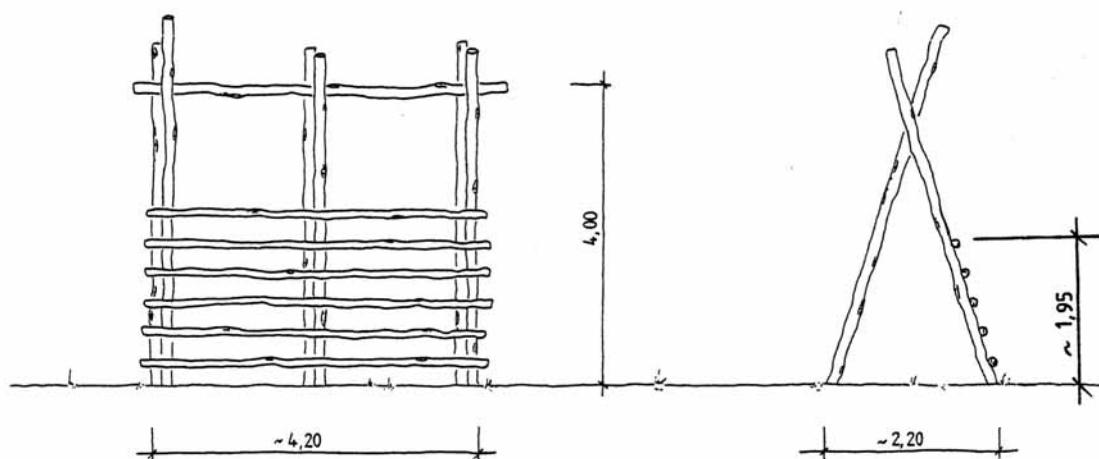



Kinderland
Emsland Spielgeräte

Jeux de grimpe et d'équilibre



Référence 071600E

Jeux de grimpe et d'équilibre

Référence 071600E

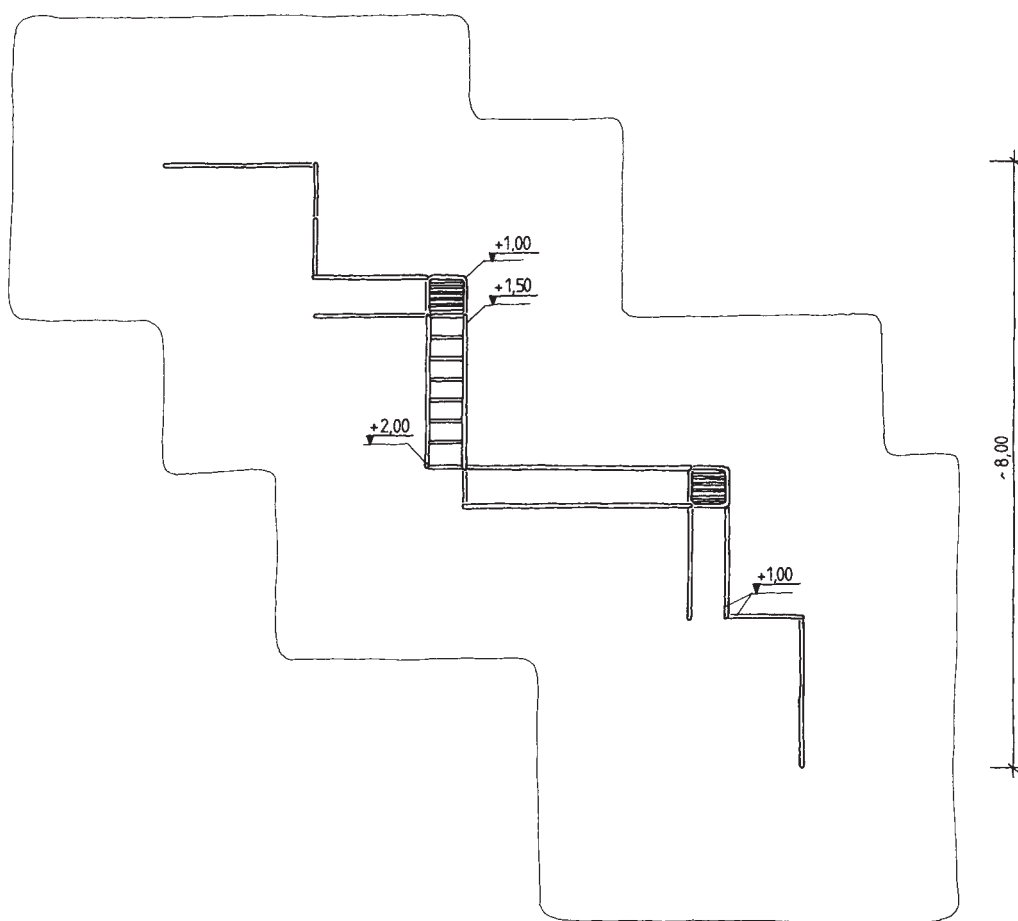
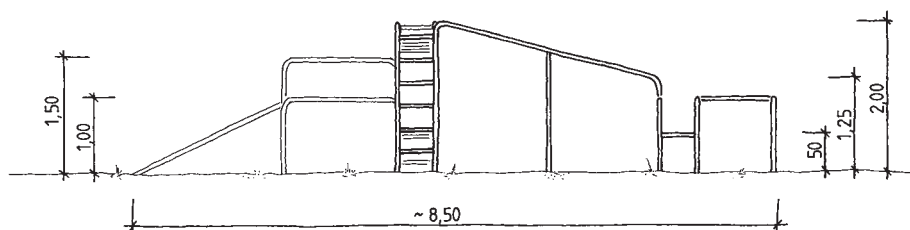



Kinderland
Emsland Spielgeräte

Jeux de grimpe et d'équilibre



Cubes à grimper



Jeux de grimpe et d'équilibre



Jeux de grimpe et d'équilibre



Référence 085060R



Jeux de grimpe et d'équilibre

Référence 085060R

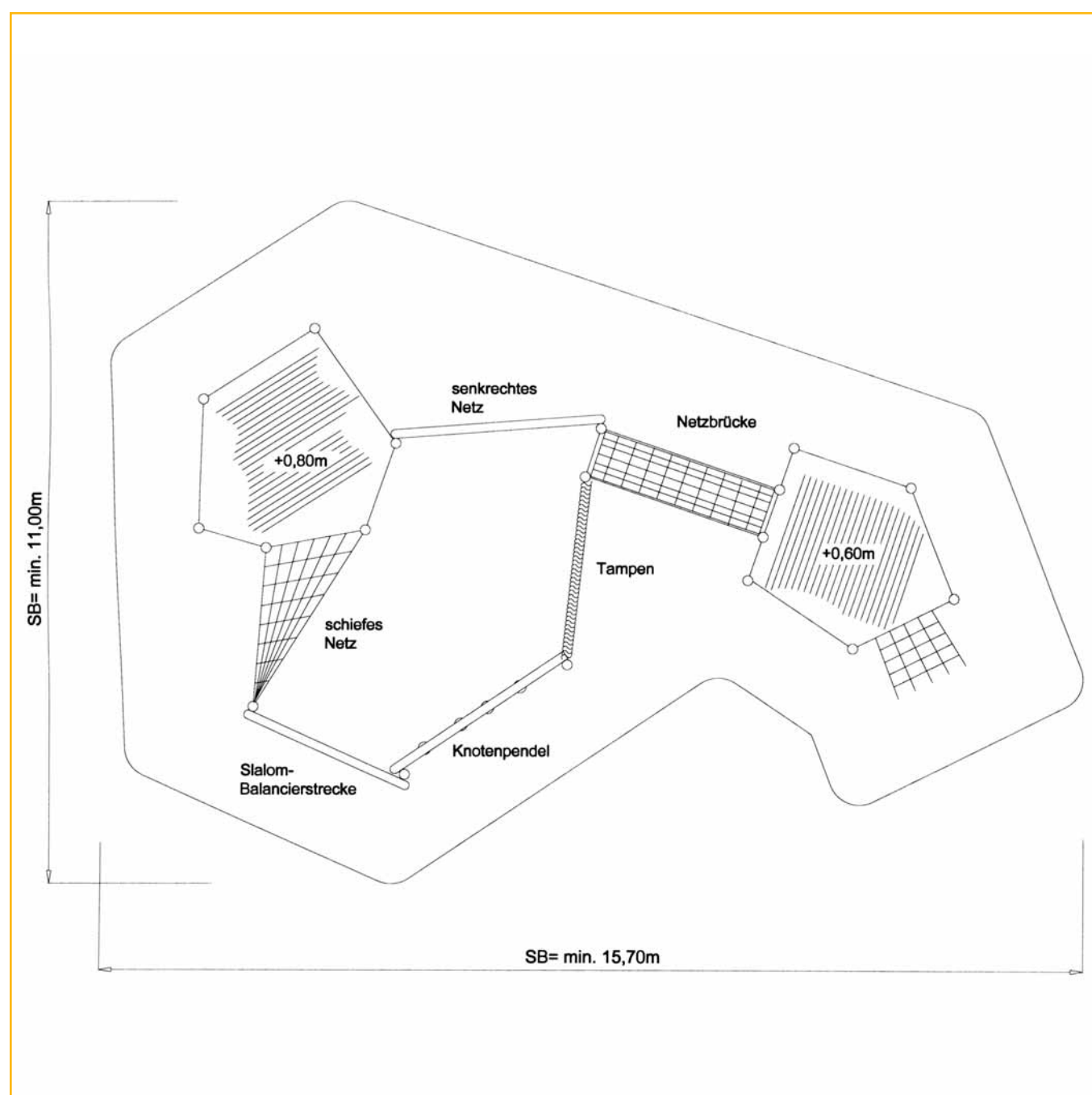



Kinderland
Emsland Spielgeräte

Jeux de grimpe et d'équilibre



Référence 085061R



Jeux de grimpe et d'équilibre

Référence 085061R

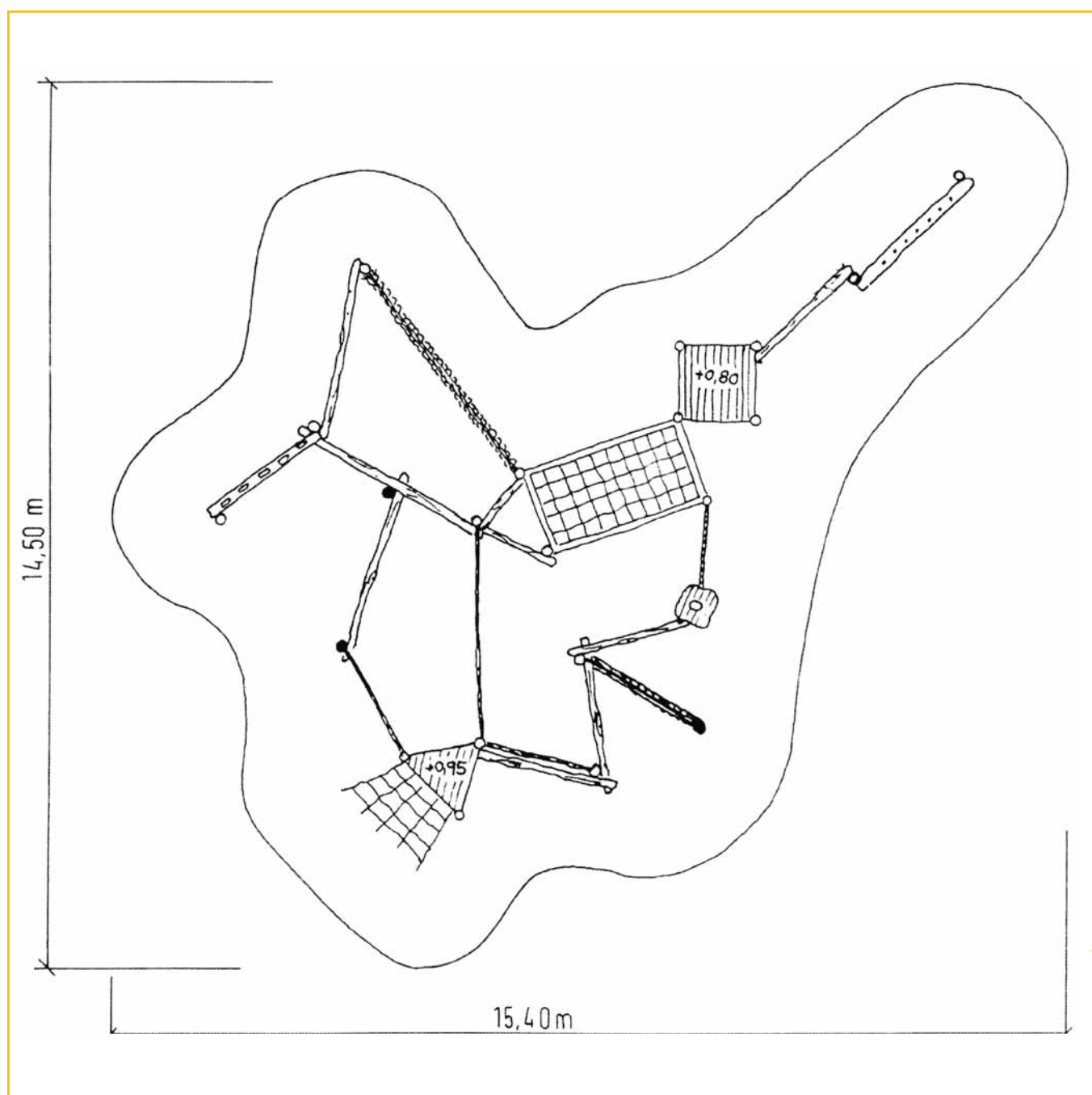

Jeux de grimpe et d'équilibre



Référence 072820R



Jeux de grimpe et d'équilibre

Référence 072820R

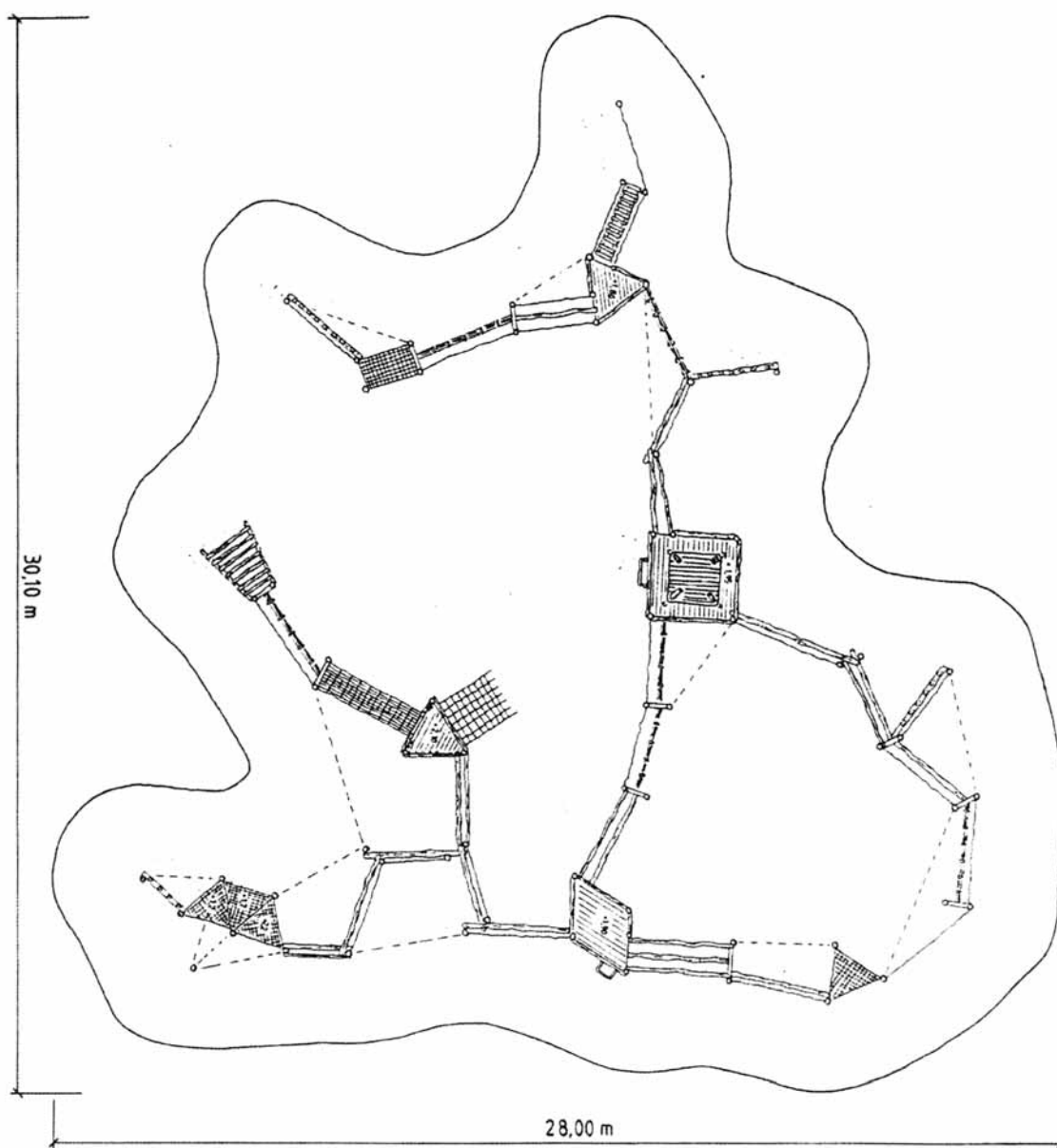



Kinderland
Emsland Spielgeräte

Jeux de grimpe et d'équilibre



Jeux d'équilibre



Jeux de grimpe et d'équilibre

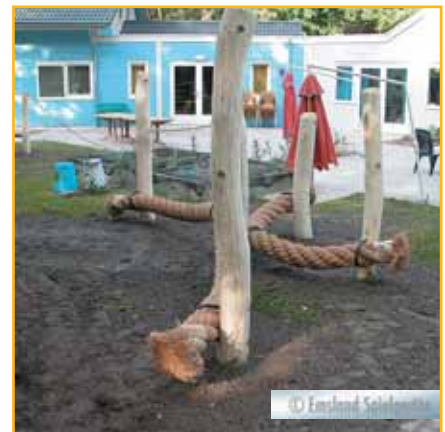



Kinderland
Emsland Spielgeräte

Jeux de grimpe et d'équilibre



Référence 072656/1D

Référence 072656/2D



Jeux de grimpe et d'équilibre

Référence 072656/1D

Référence 072656/2D

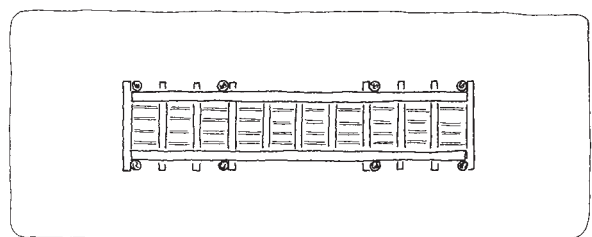
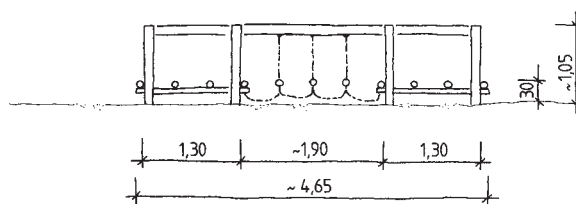
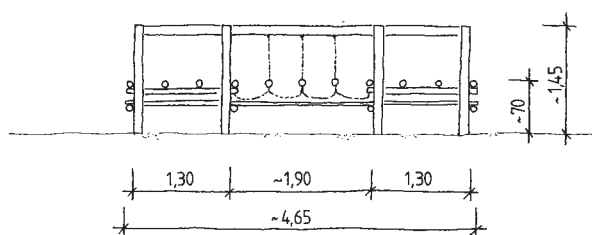

mit Boden
07 2656/1

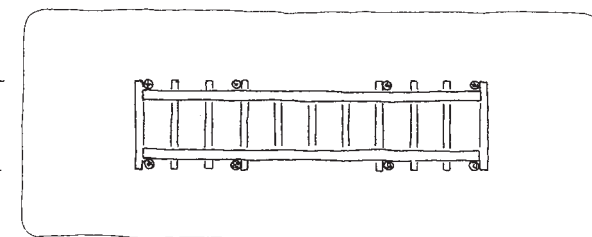

ohne Boden
07 2656/2



Kinderland
Emsland Spielgeräte

Jeux de grimpe et d'équilibre



Référence 074200R

Référence 078020D

Jeux de grimpe et d'équilibre

Référence 074200R

Référence 078020D

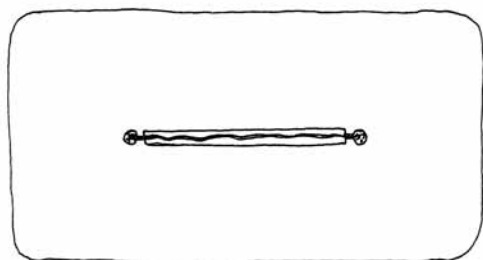
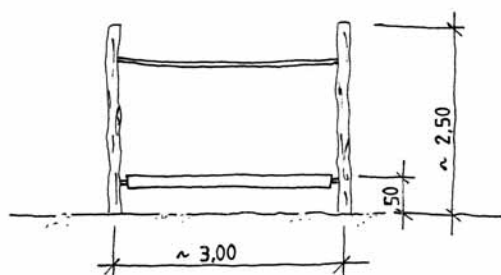

Rollbalken mit Hangeseil
074200R

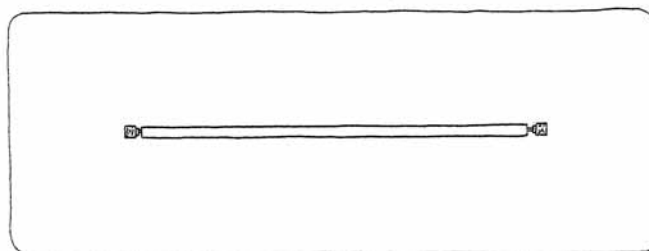
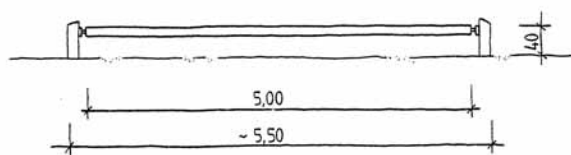

Wackelbalancierbalken
078020D

Jeux de grimpe et d'équilibre



Référence GAT 007050D



Jeux de grimpe et d'équilibre

Référence GAT 007050D

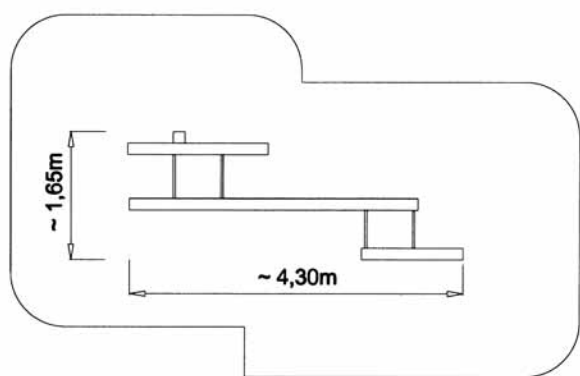

Jeux de grimpe et d'équilibre



Référence 078050R

Jeux de grimpe et d'équilibre

Référence 078050R

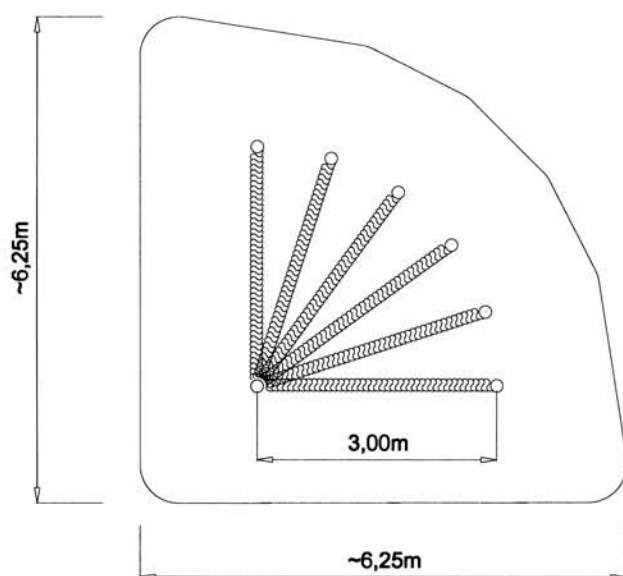

Jeux de grimpe et d'équilibre



Référence 072101

Référence 072102

Jeux de grimpe et d'équilibre

Référence 072101V, VL

Référence 072102V, VL

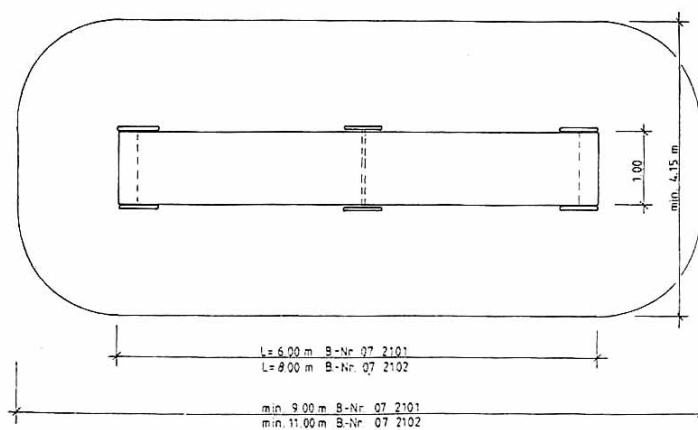
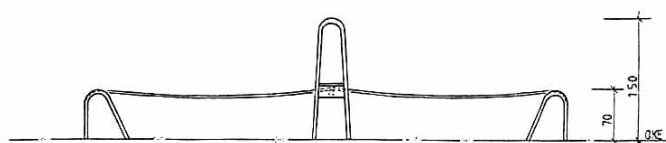



Kinderland
Emsland Spielgeräte

Jeux de grimpe et d'équilibre

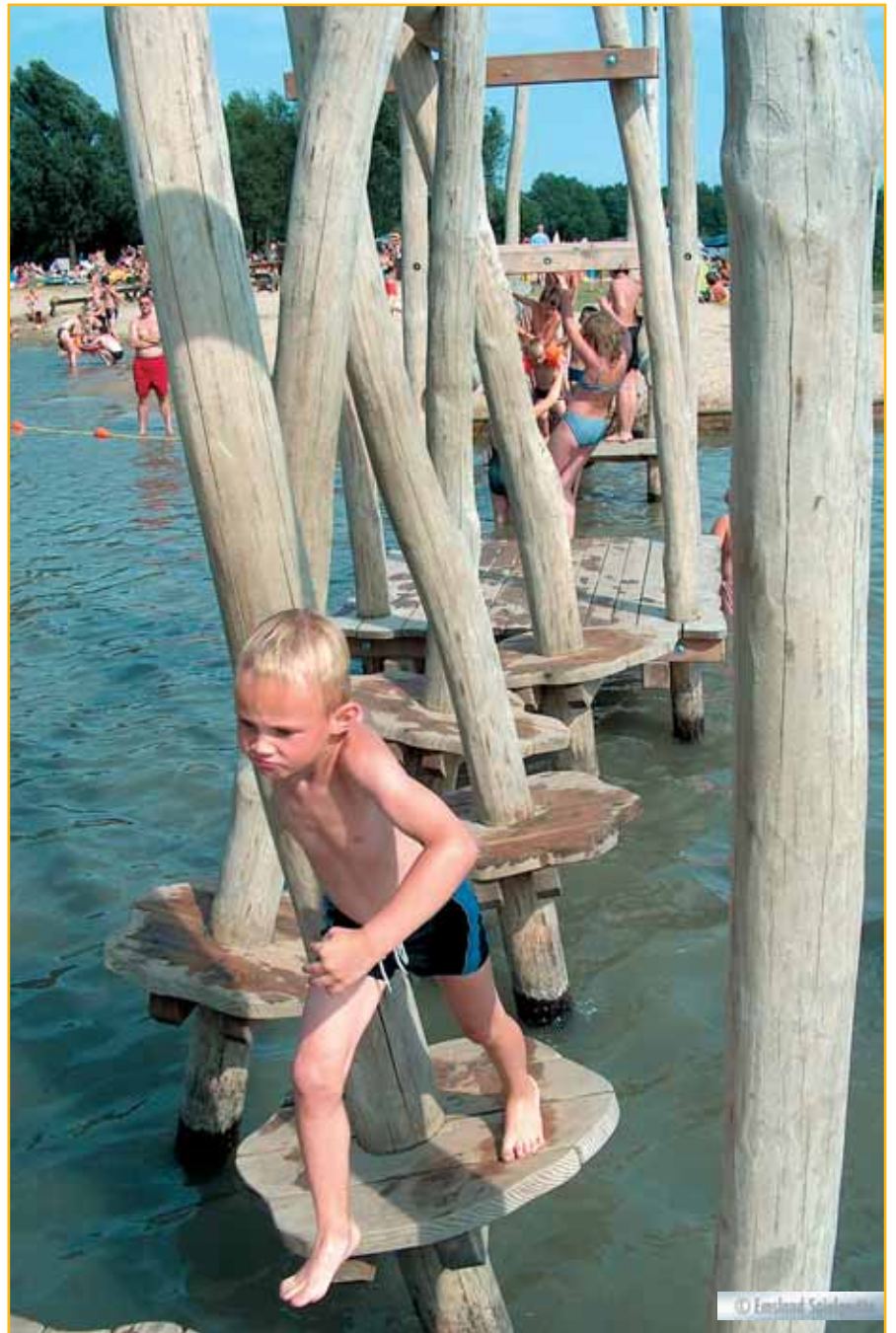

Référence 072710

Référence 072720

Jeux de grimpe et d'équilibre

Référence 072710D, R

Référence 072720D, R

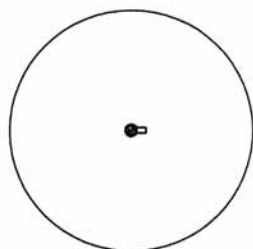
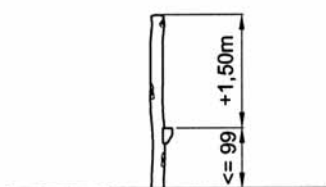

Stelze
07 2710R, D

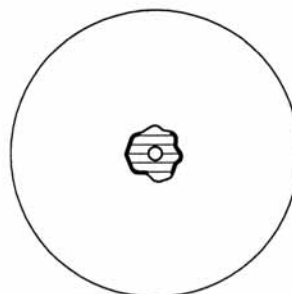
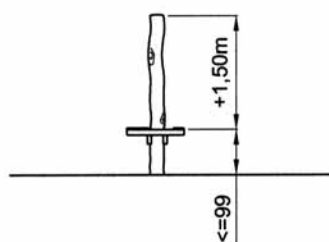

Laftellerpfosten
07 2720R, D



Kinderland
Emsland Spielgeräte

Jeux de grimpe et d'équilibre



Référence GAT 040100T

Jeux de grimpe et d'équilibre

Référence GAT 040100T

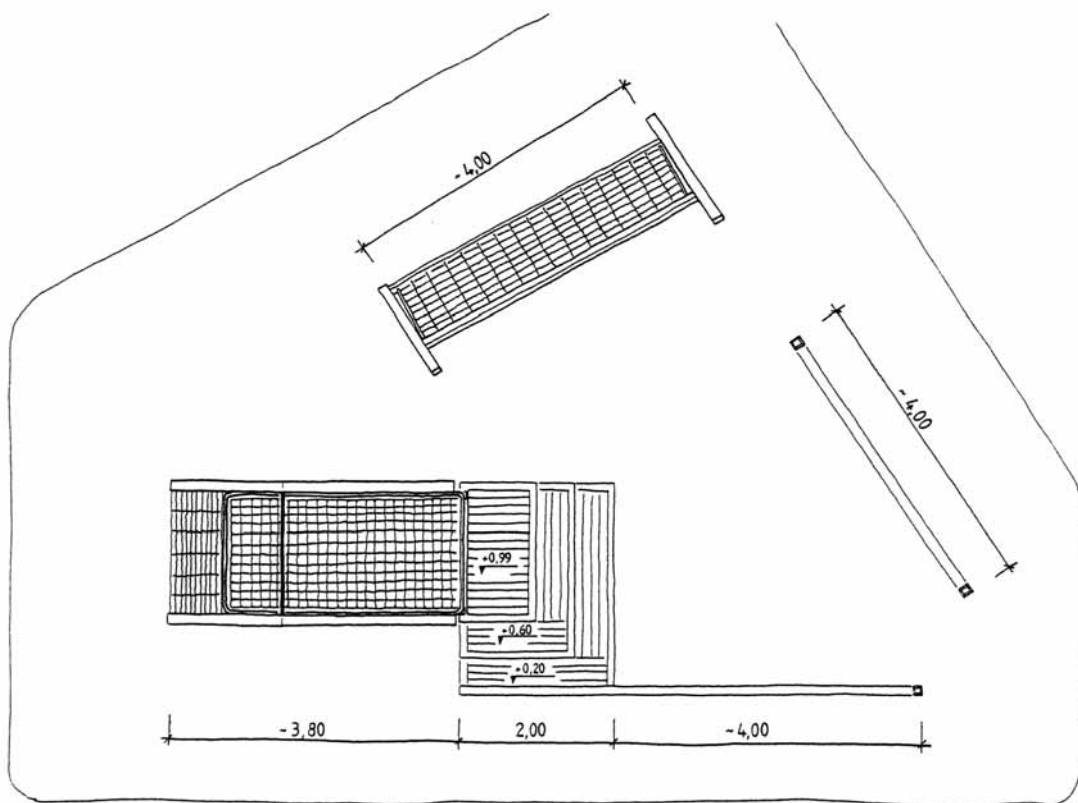
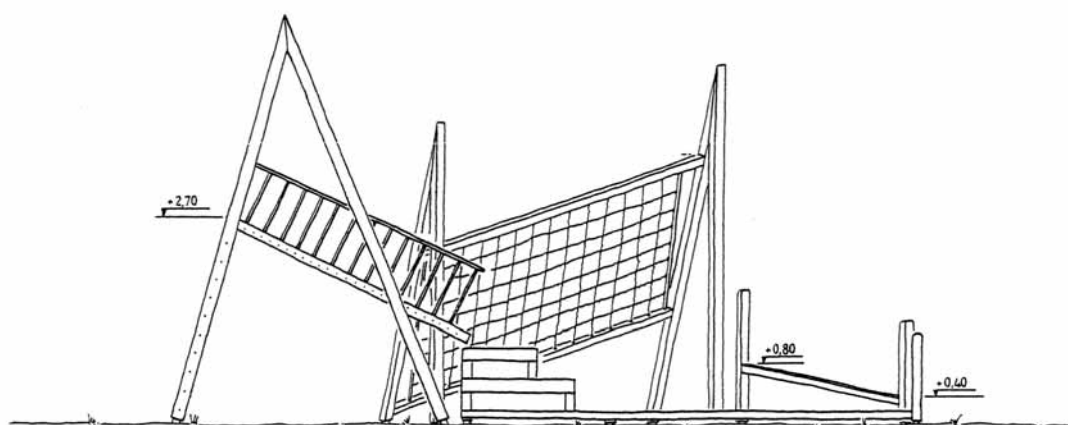



Référence 103010R

Référence 085105R



Maisonnettes Cabanes et Tours

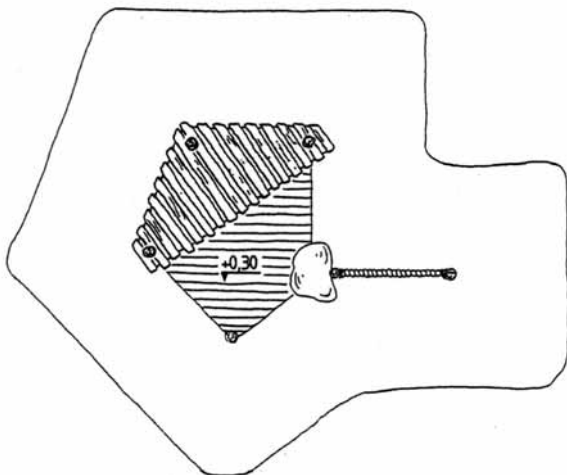
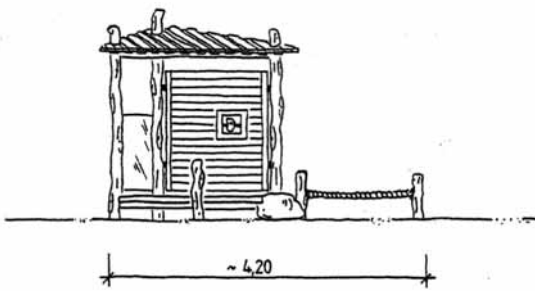

Pantoffel-Spielhaus 103010R

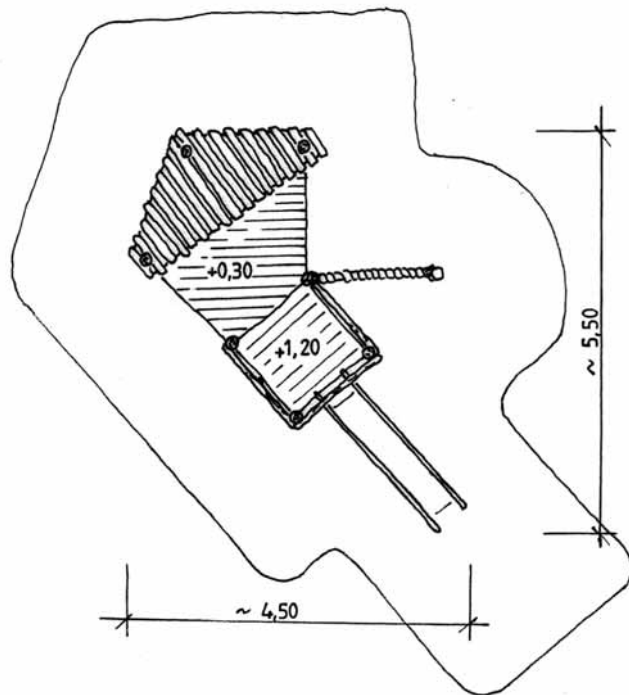

Pantoffel-Kombination 085105R



Référence 103014R

Maisonnettes Cabanes et Tours

Référence 103014R

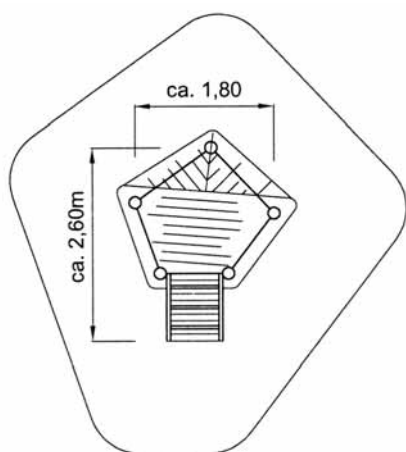
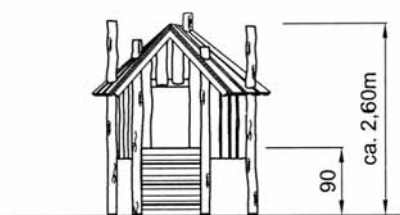



Référence GAT 070301R

Maisonnettes Cabanes et Tours

Référence GAT 070301R

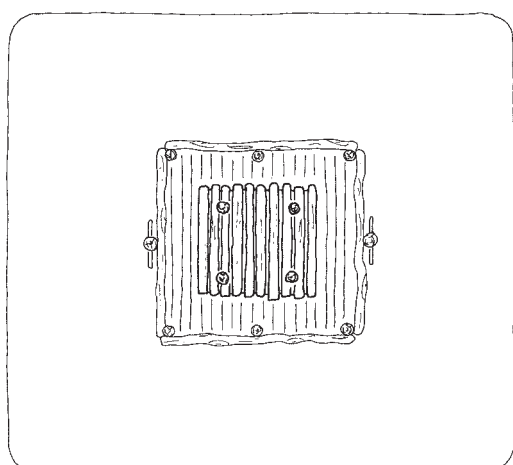
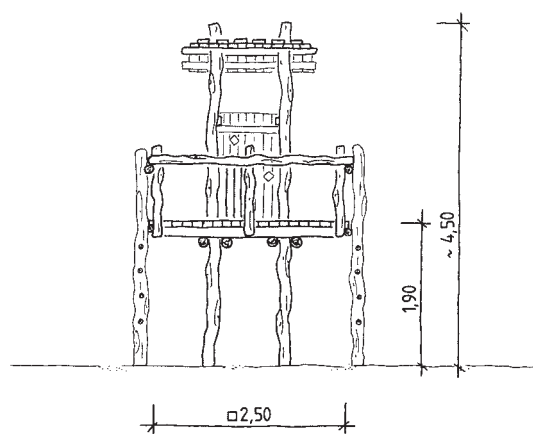

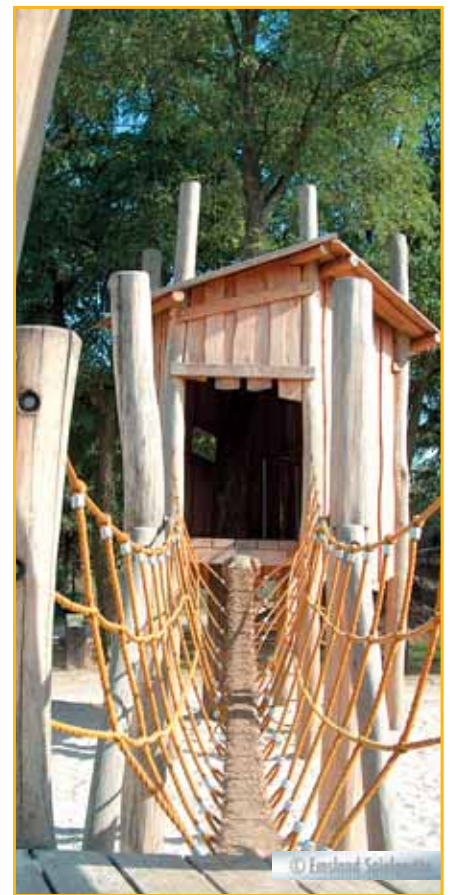
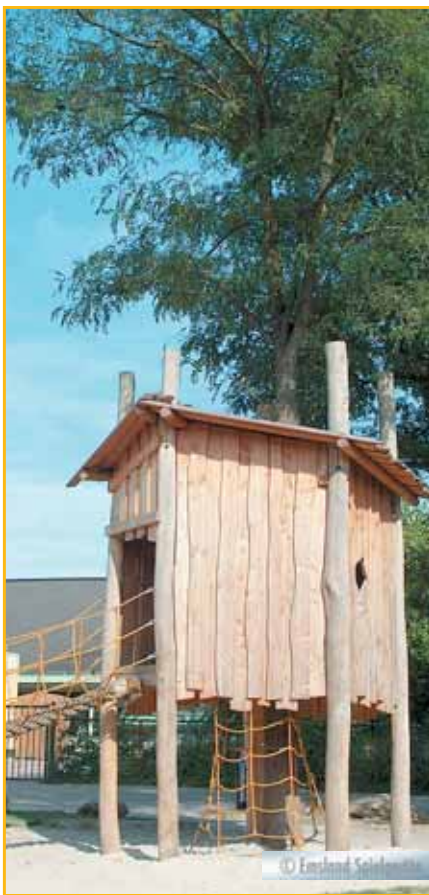

Cabanes



Maisonnettes Cabanes et Tours





Référence 085110R

Maisonnettes Cabanes et Tours

Référence 085110R

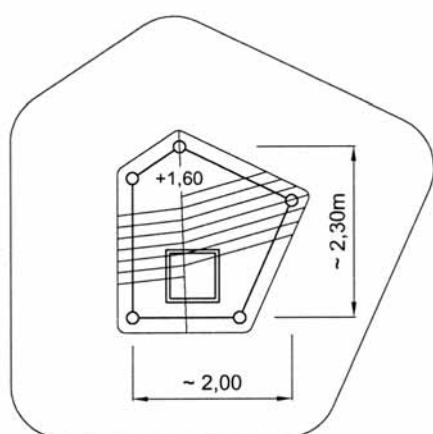



Référence 085035R



Maisonnettes Cabanes et Tours

Référence 085035R

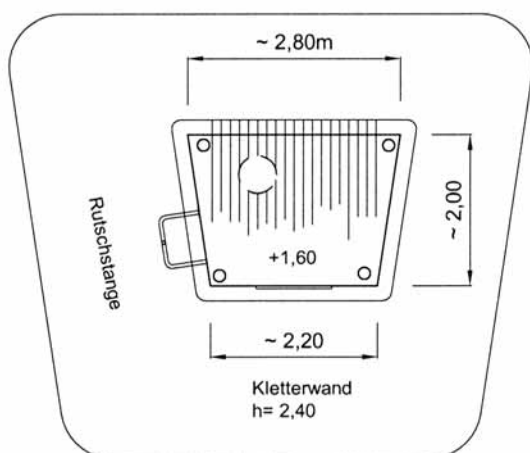



Référence 042700R

Référence 042705R

Maisonnettes Cabanes et Tours

Référence 042700R

Référence 042705R

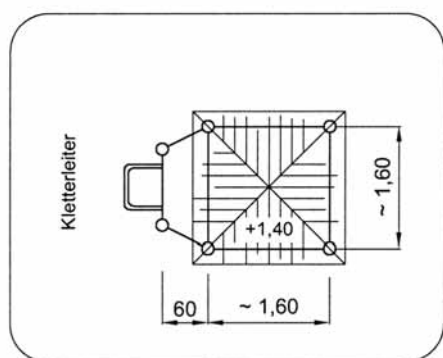

Baumhaus Göhren I
04 2700R



Référence 103015

Référence 102592

Maisonnettes Cabanes et Tours

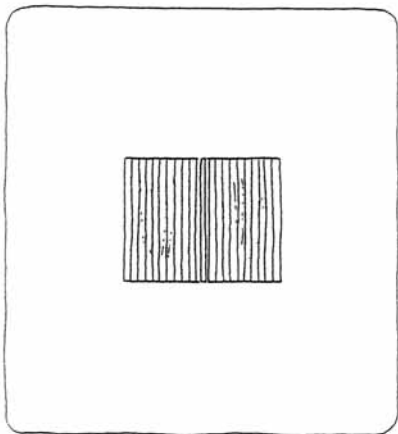
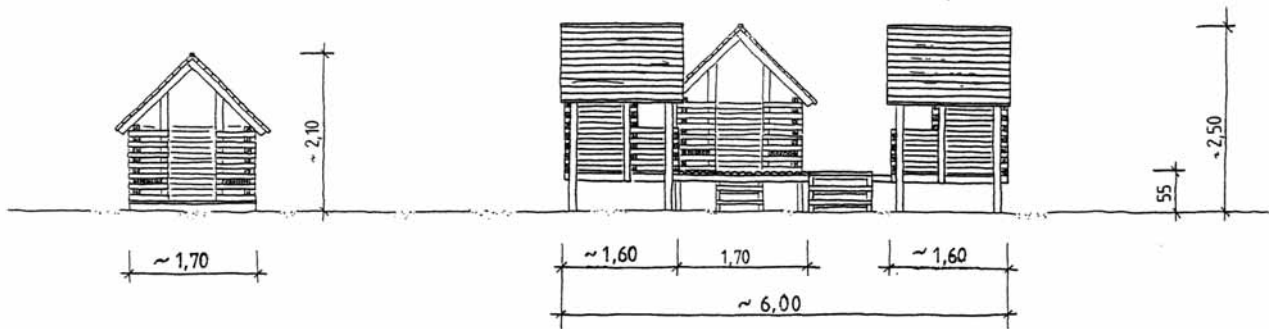

Kinderhaus
10 3015D, R

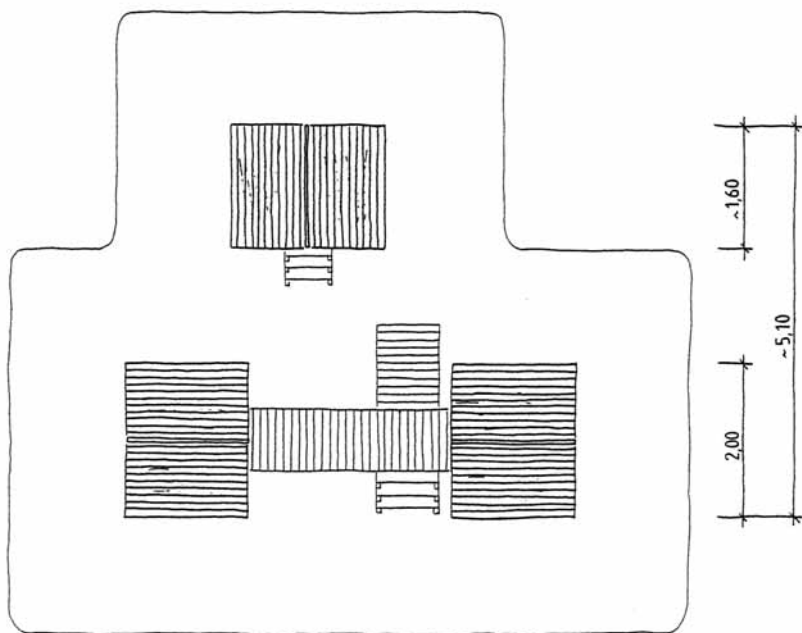

Dorfhausgruppe
10 2592D, R



Référence 042520R

Maisonnettes Cabanes et Tours

Référence 042520R

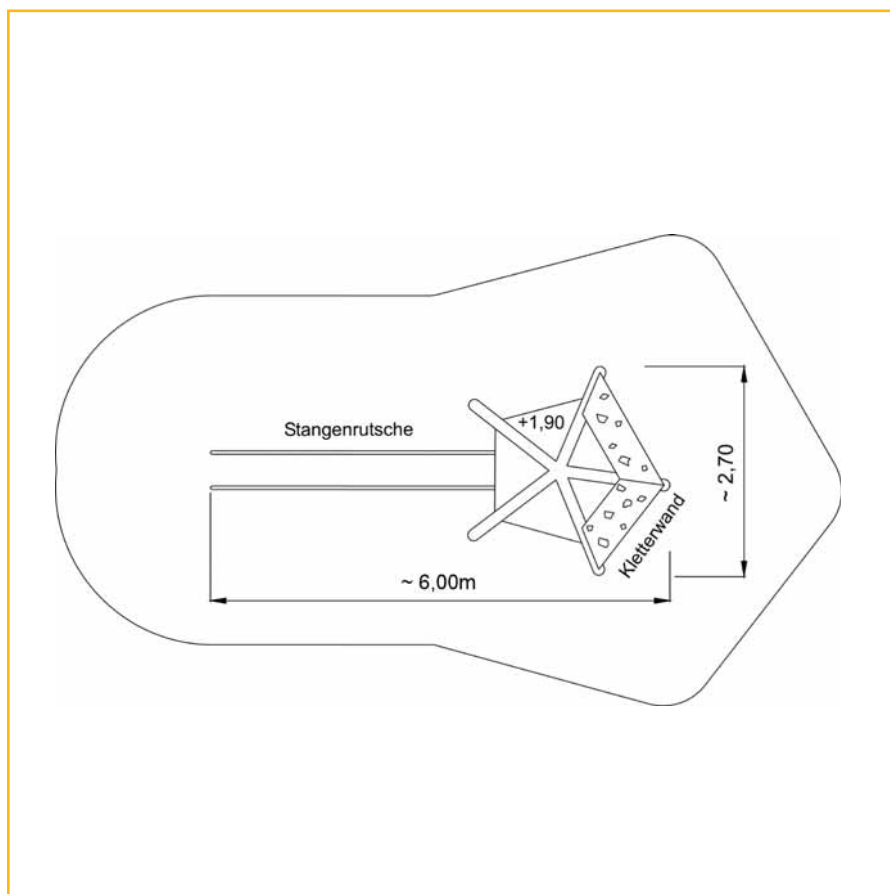

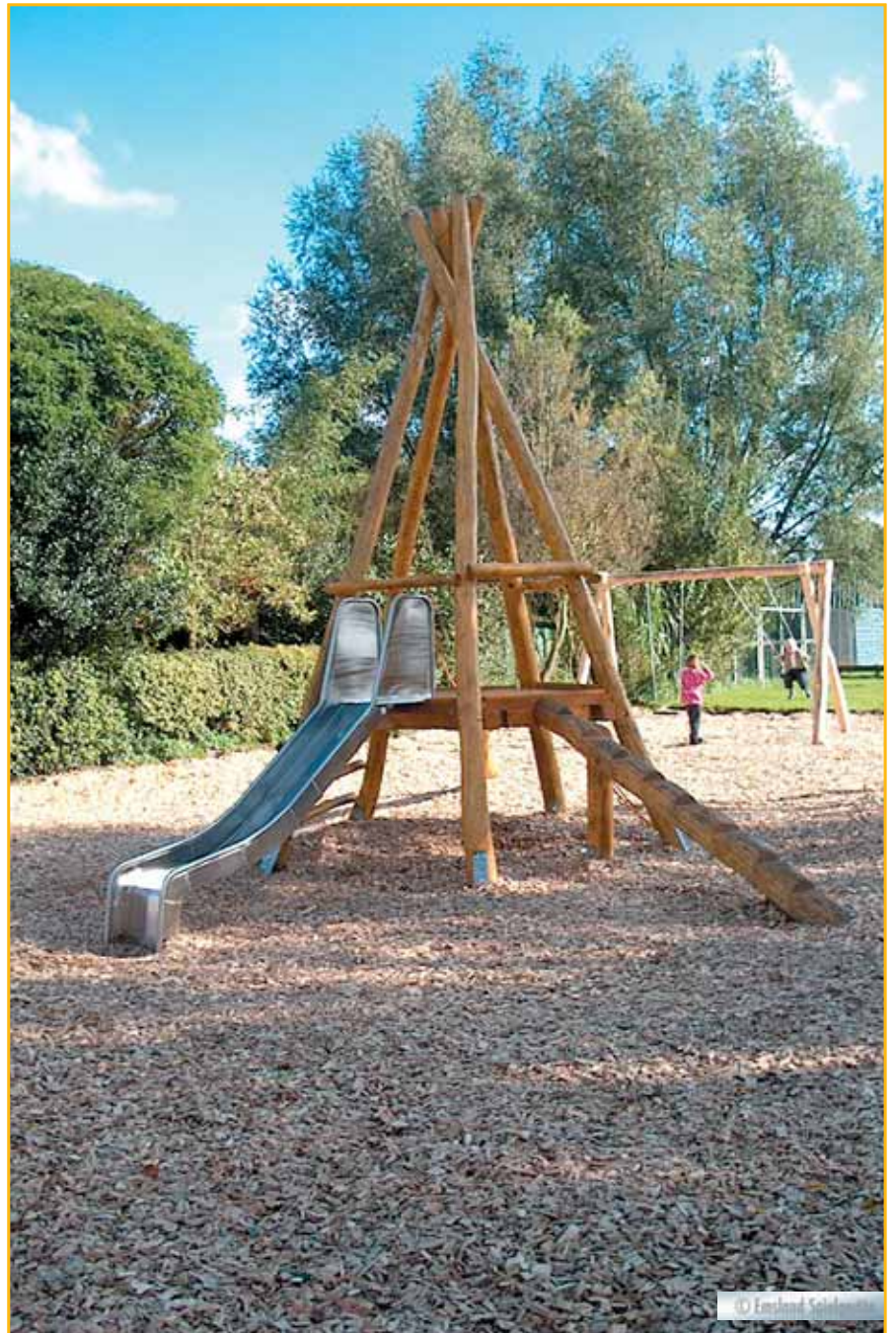
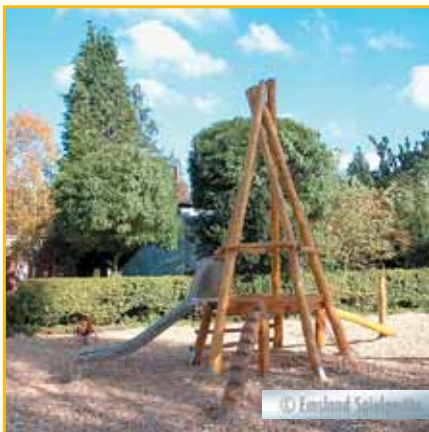

Référence 042510R

Maisonnettes Cabanes et Tours

Référence 042510R

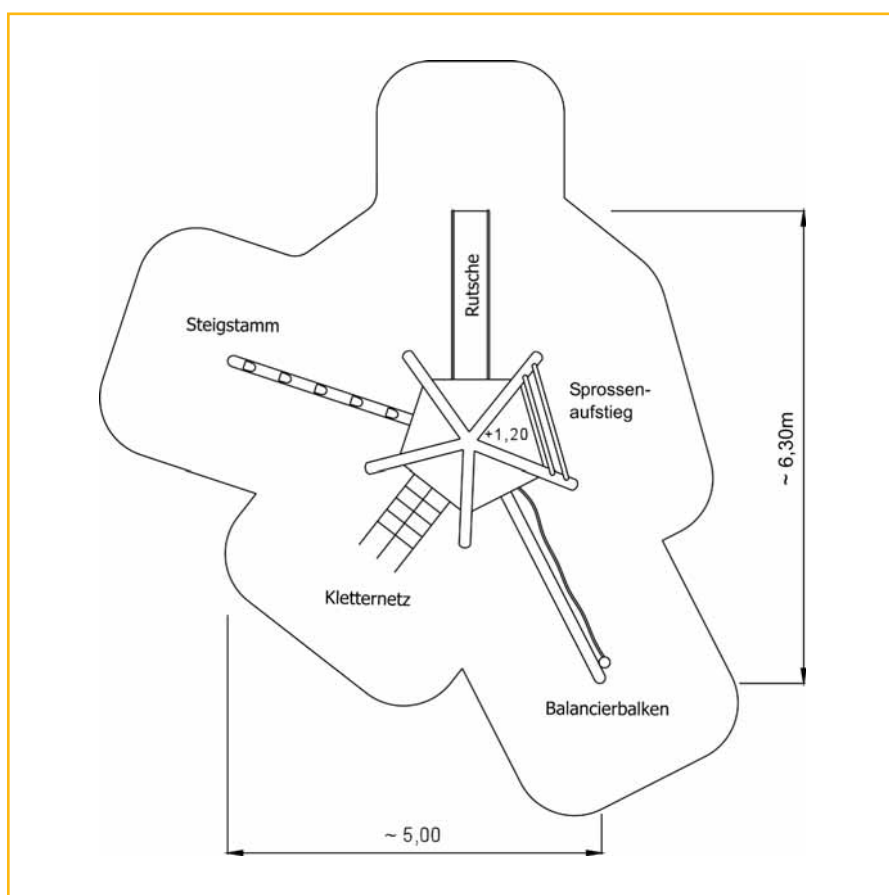



Référence 042530R



Maisonnettes Cabanes et Tours

Référence 042530R

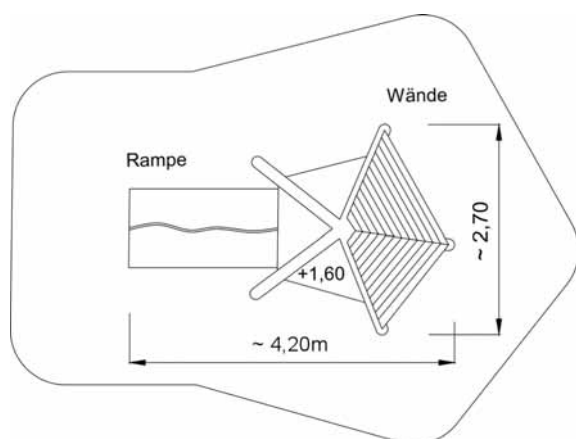



Référence 042547/1D

Référence 042547/2D

Maisonnettes Cabanes et Tours

Référence 042547/1D

Référence 042547/2D

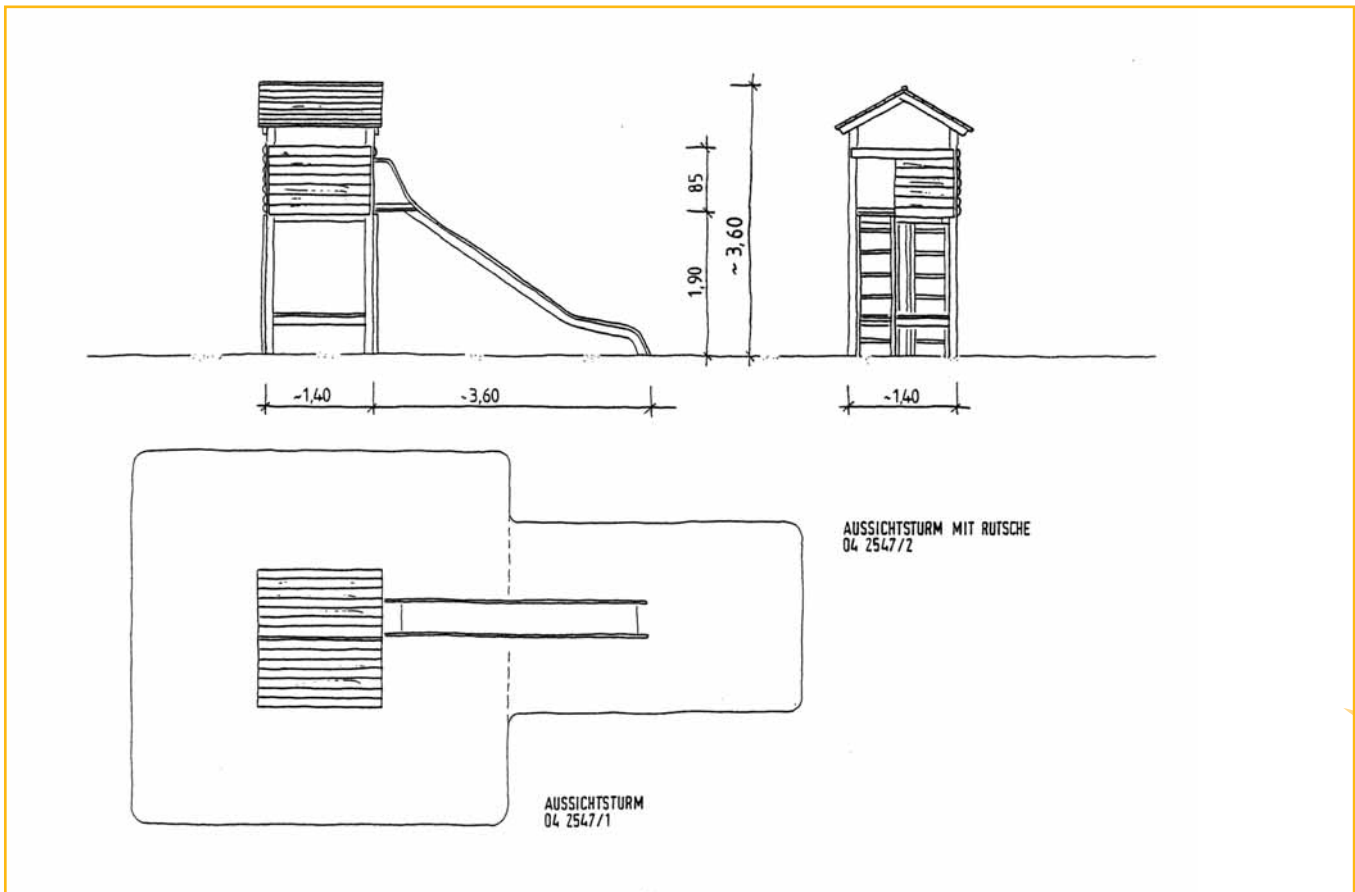

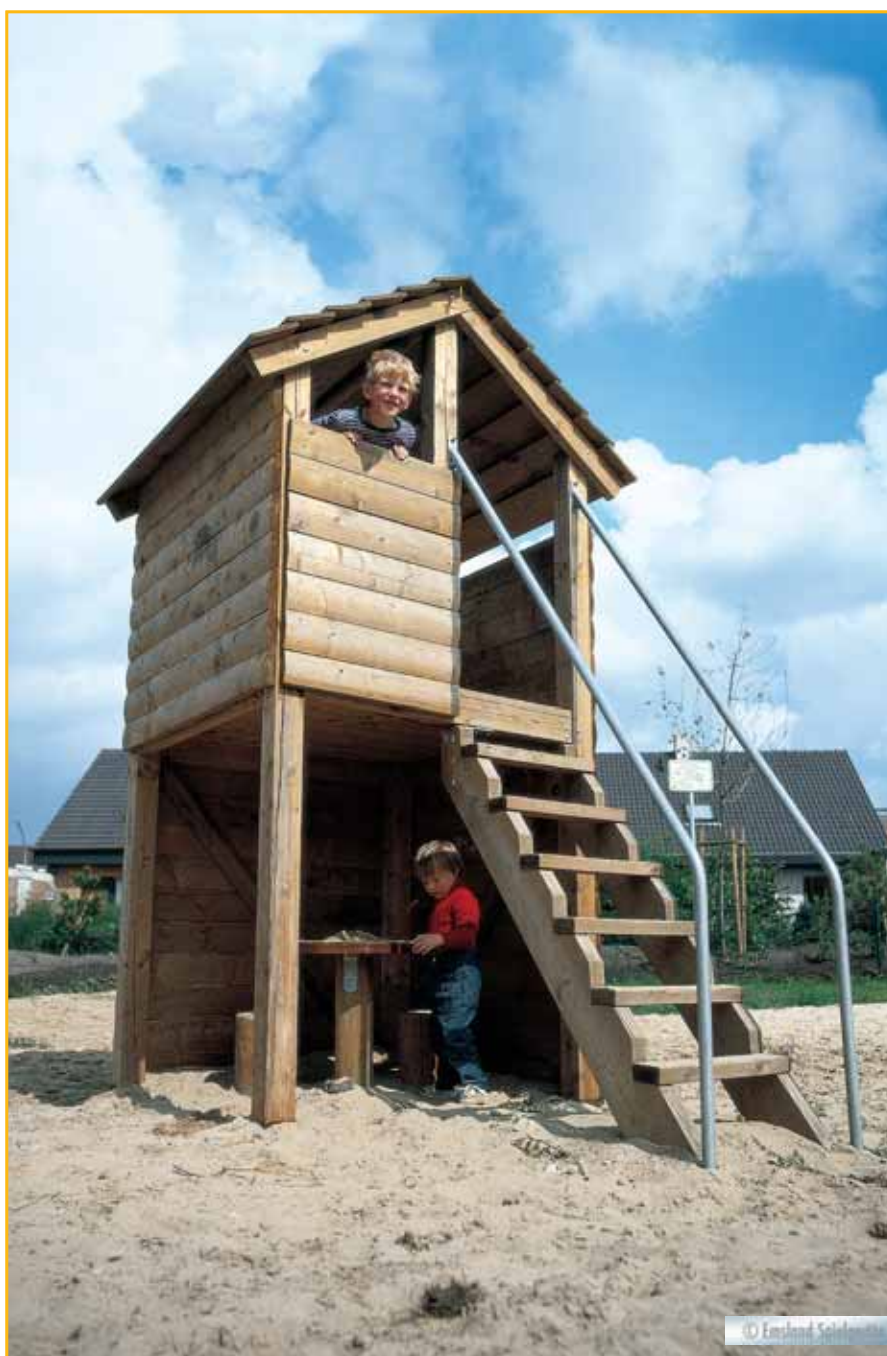

Référence 102552D

Maisonnettes Cabanes et Tours

Référence 102552D

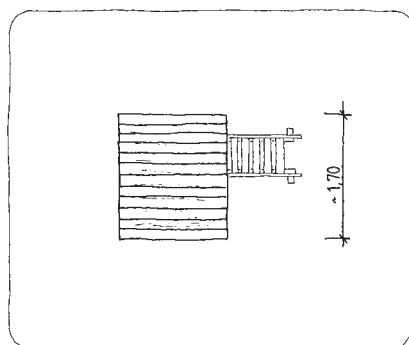
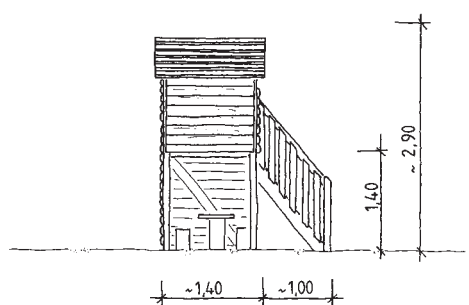



Référence GAT 001000T



Maisonnettes Cabanes et Tours

Référence GAT 001000T

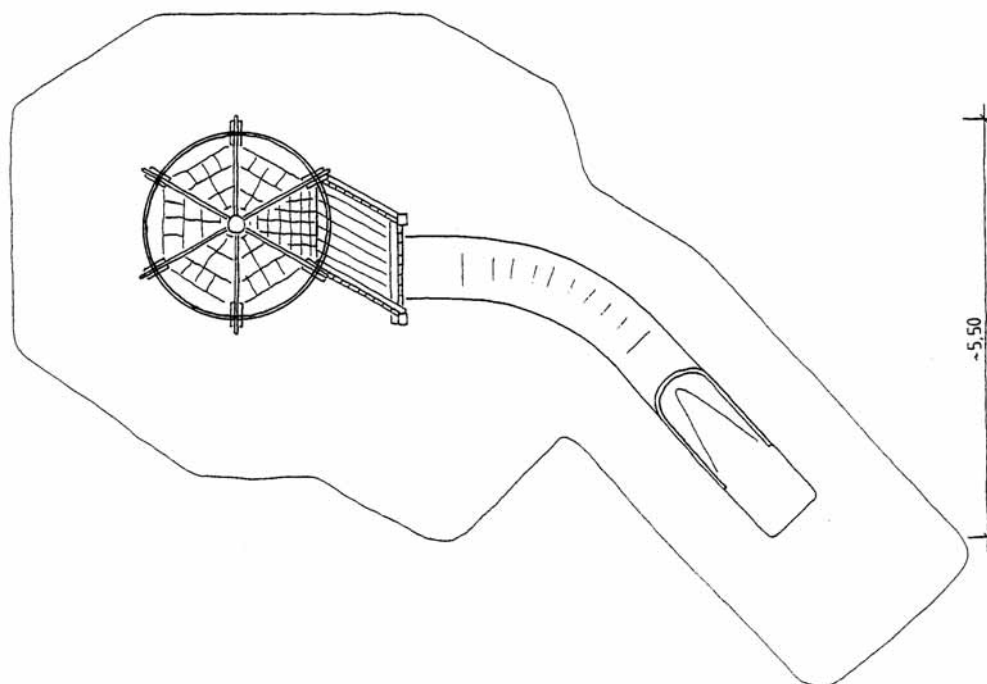
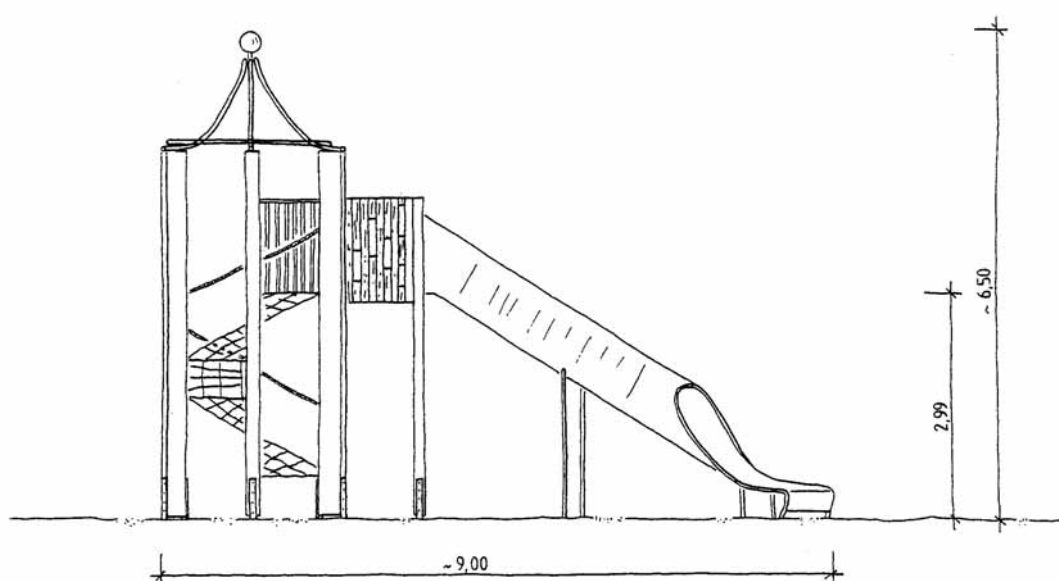



Tour Aigner



Maisonnettes Cabanes et Tours





Référence 042300R

Maisonnetes Cabanes et Tours

Référence 042300R

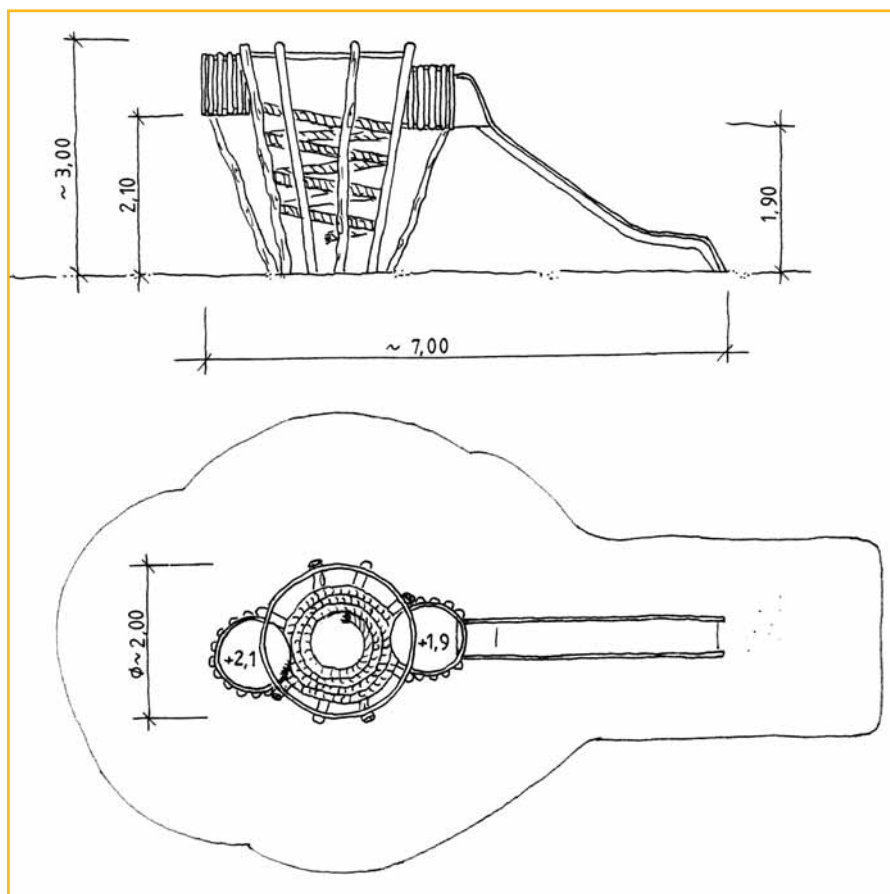

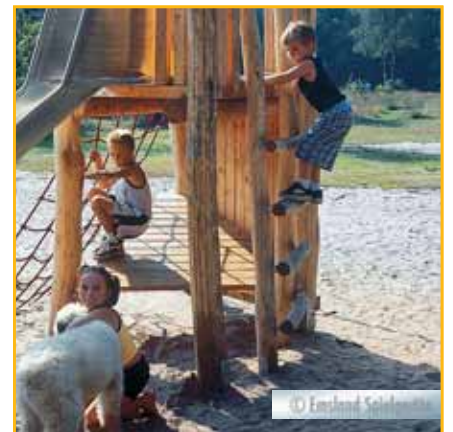

Référence GAT 003800R

Maisonnettes Cabanes et Tours

Référence GAT 003800R

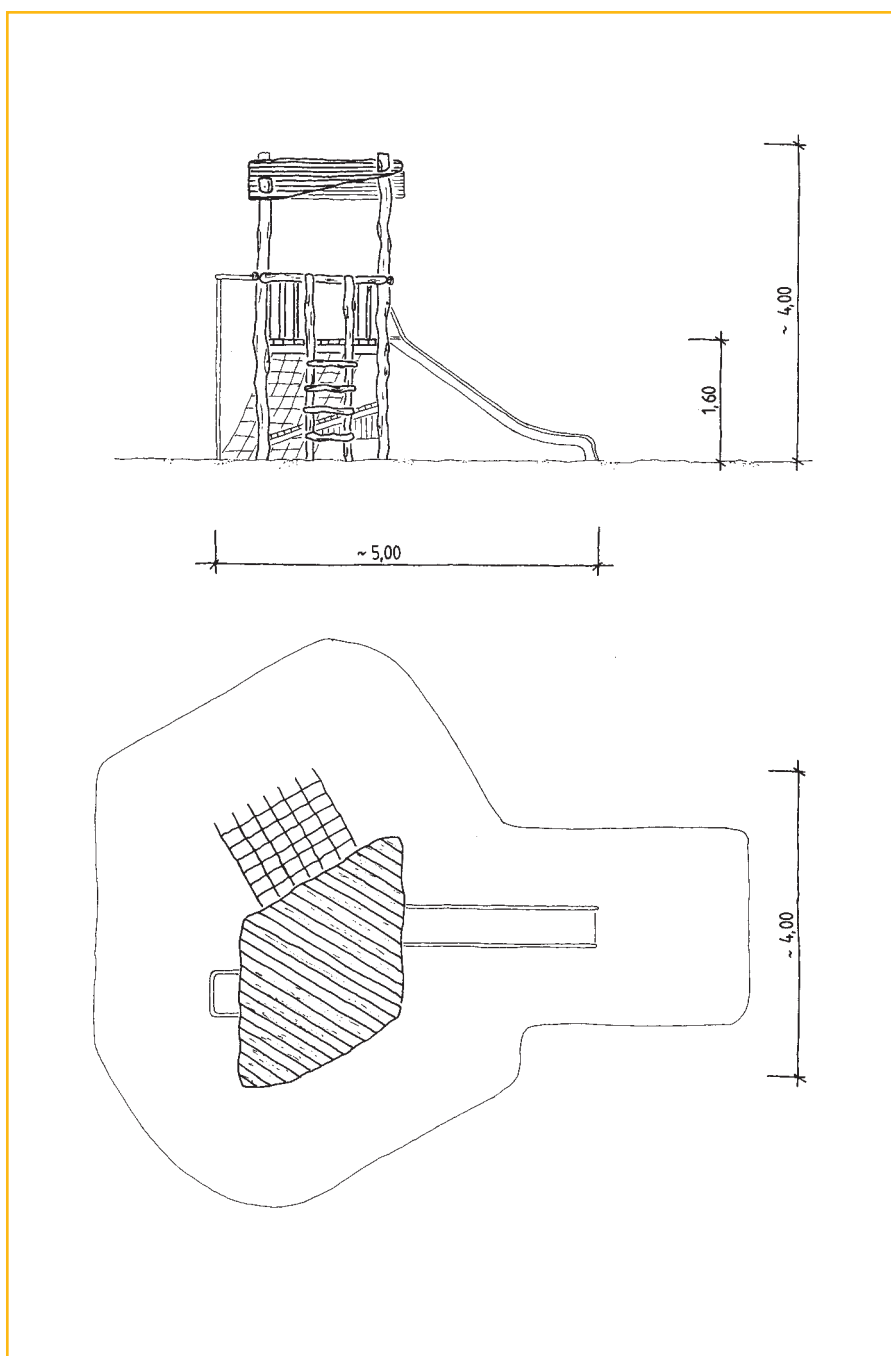



Référence 085090R



Maisonnettes Cabanes et Tours

Référence 085090R

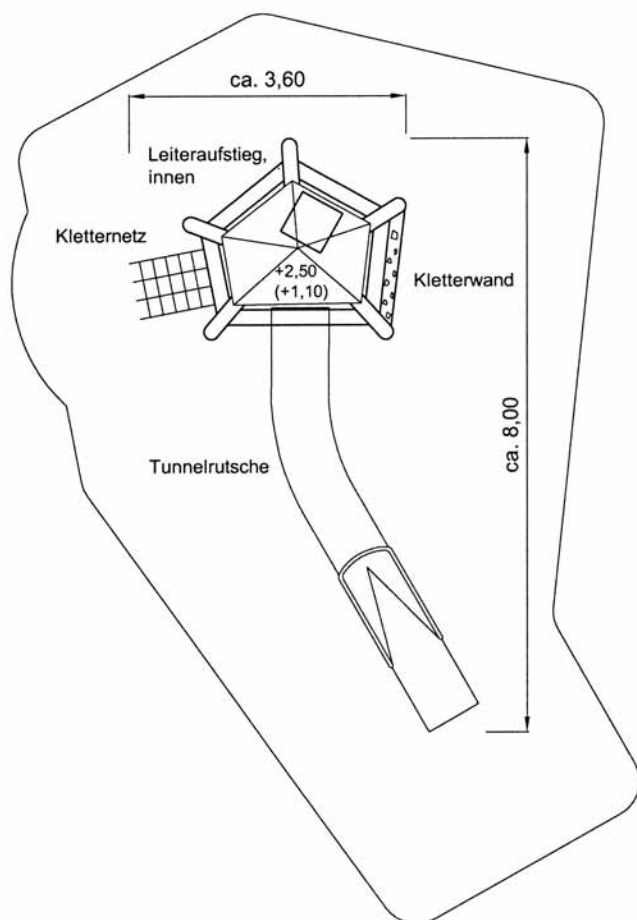



Référence 042400R

Maisonnettes Cabanes et Tours

Référence 042400R

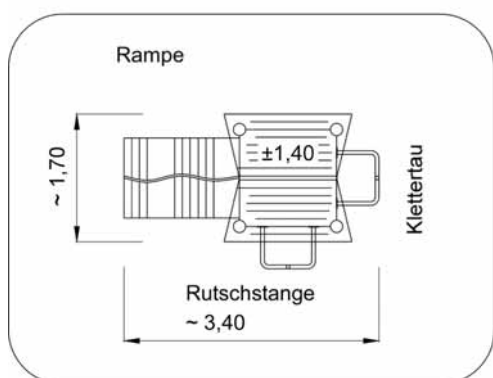



Référence 082594

Maisonnettes Cabanes et Tours

Référence 082594D,R

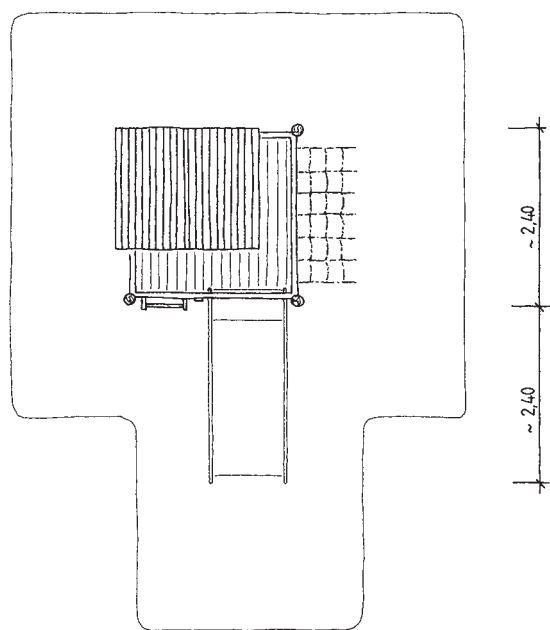
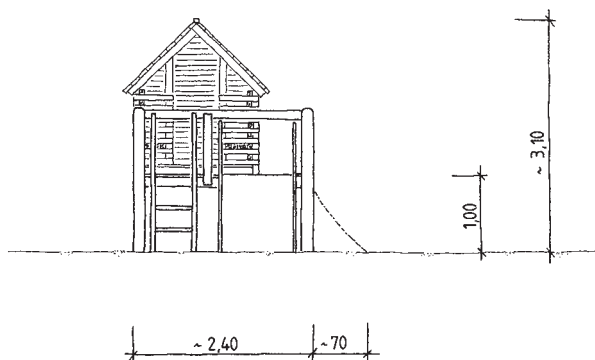

Maisonnettes Cabanes et Tours



Référence GAT 000201T



Maisonnettes Cabanes et Tours

Référence GAT 000201T

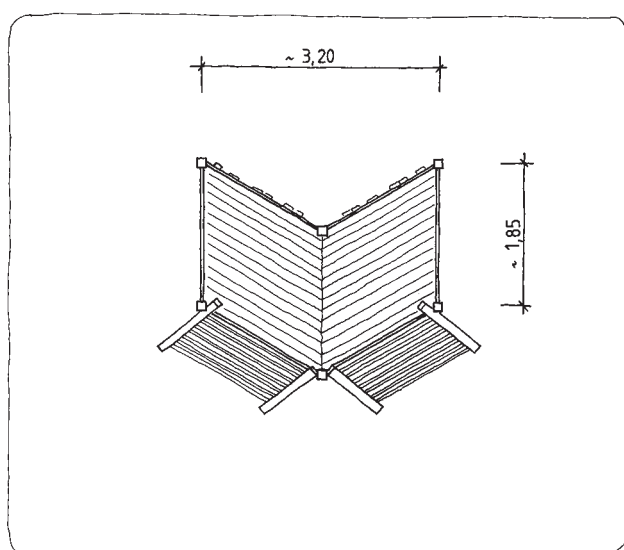
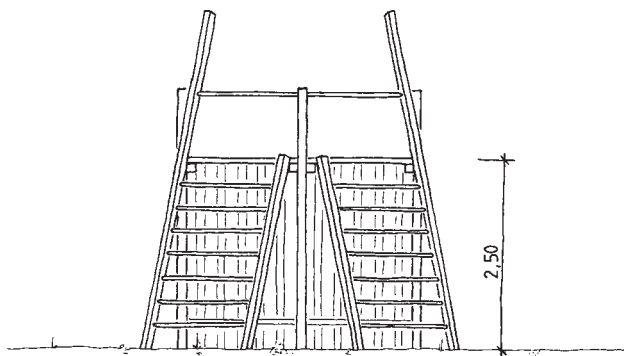

Maisonnettes Cabanes et Tours



Les Cubes



Maisonnettes Cabanes et Tours

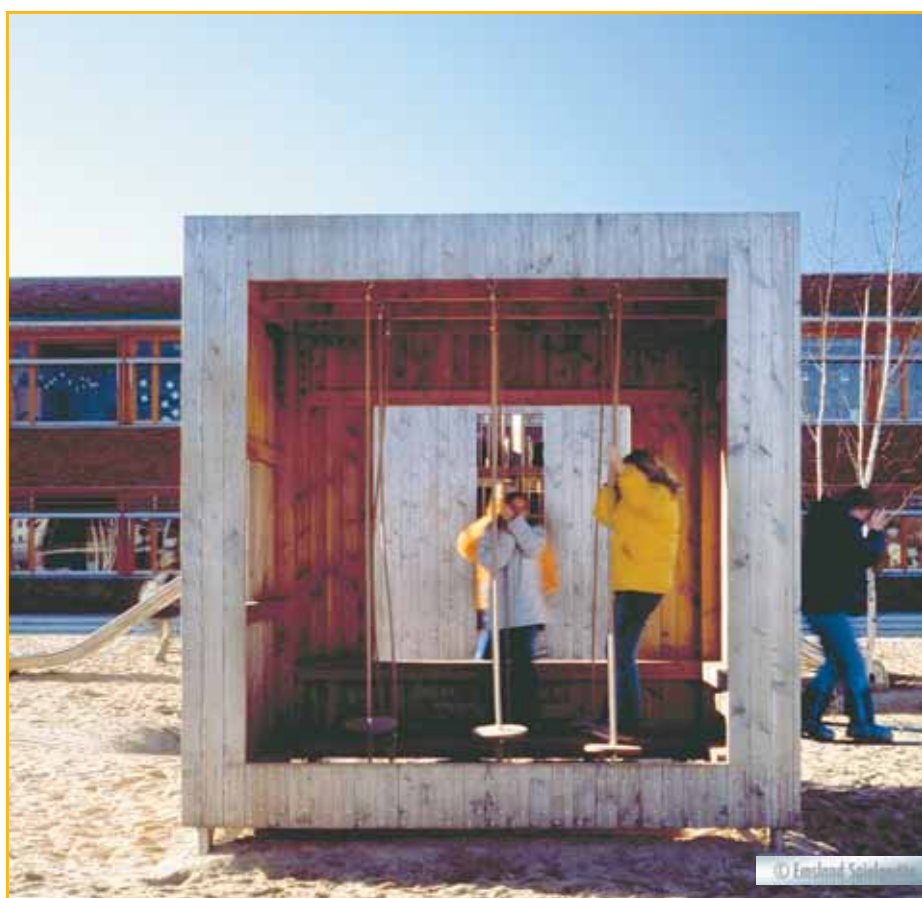



Référence 085075D

Maisonnettes Cabanes et Tours

Référence 085075D

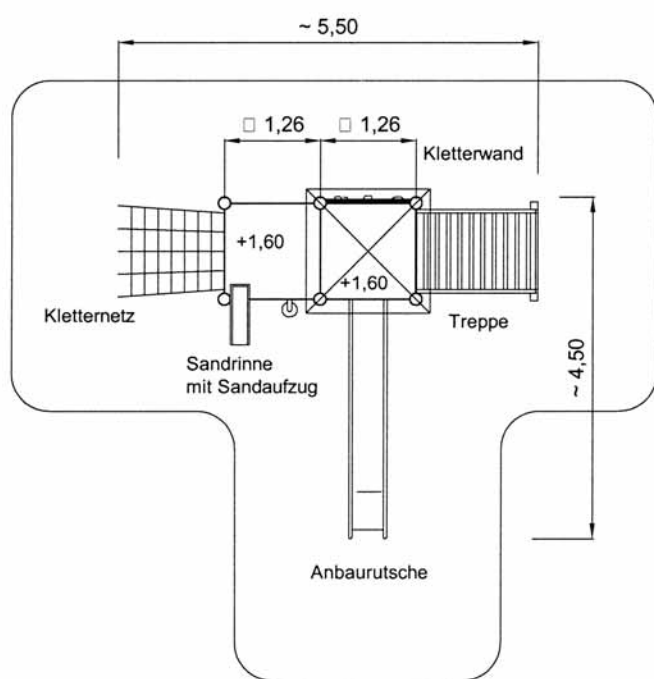

Multi-activités



Référence 131613/1

Référence 131613/2

Référence 131621

Multi-activités

Référence 131613/1V, VL

Référence 131613/2V, VL

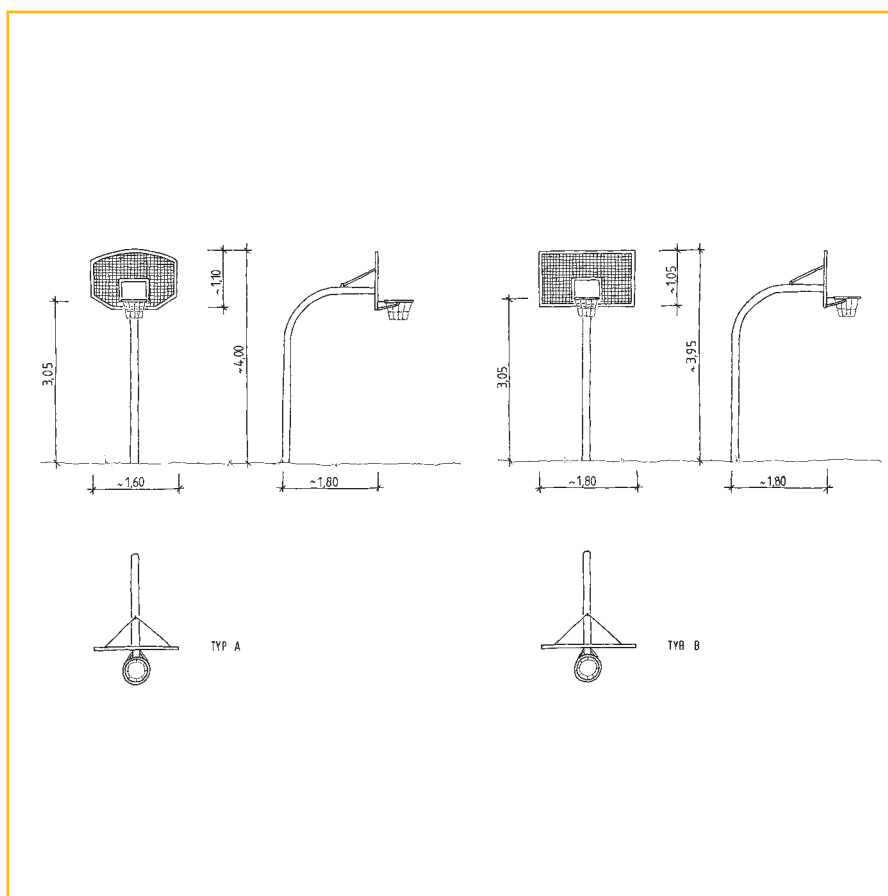

Référence 131621V, VL

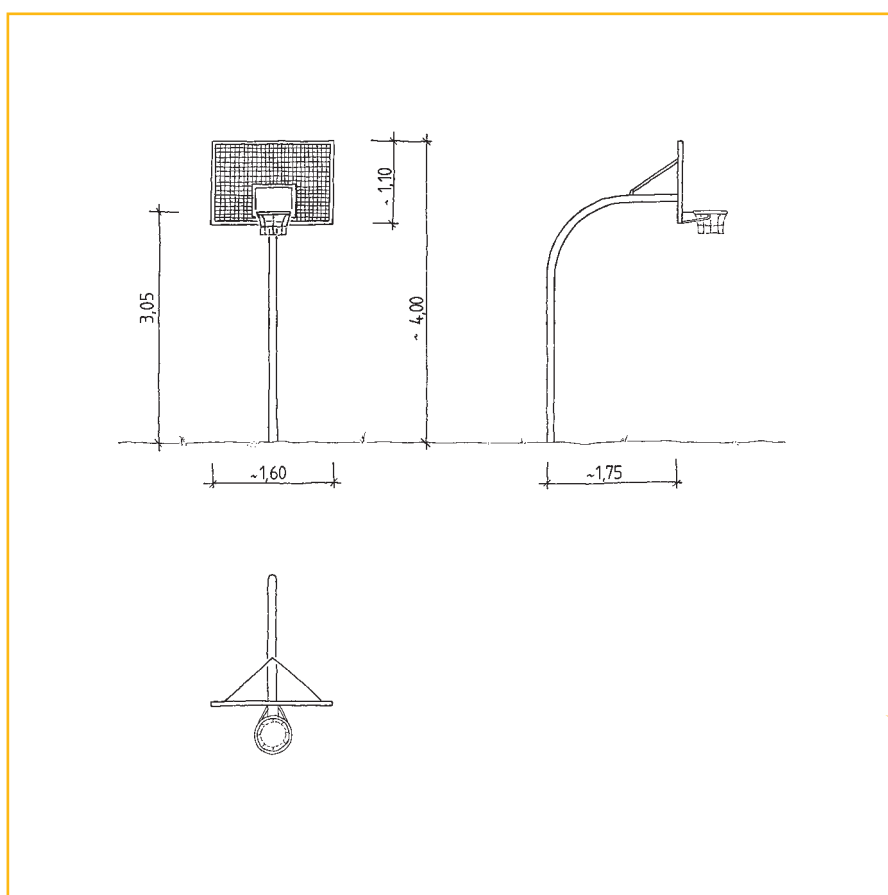

Multi-activités



Référence 131632

Référence 131633

Multi-activités

Référence 131632V, VL

Référence 131633V, VL

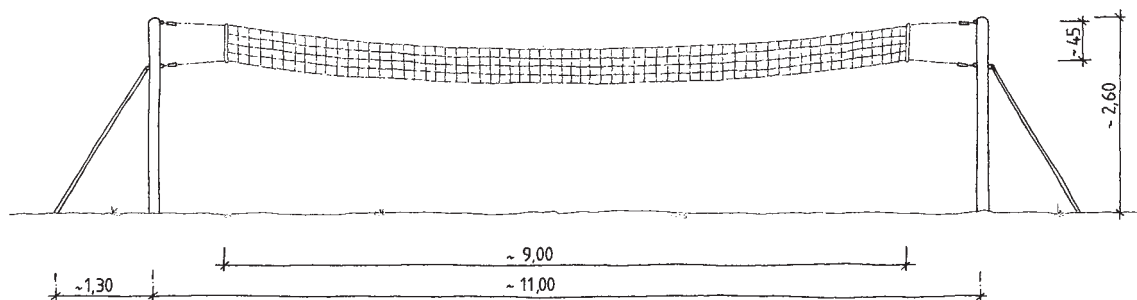

BEACHBALL - VOLLEYBALL - ANLAGE

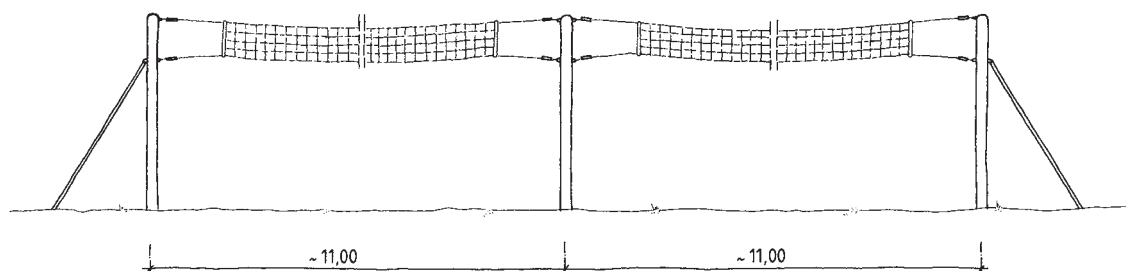

DOPPELANLAGE

Multi-activités



Référence 131625

Multi-activités

Référence 131625V, VL

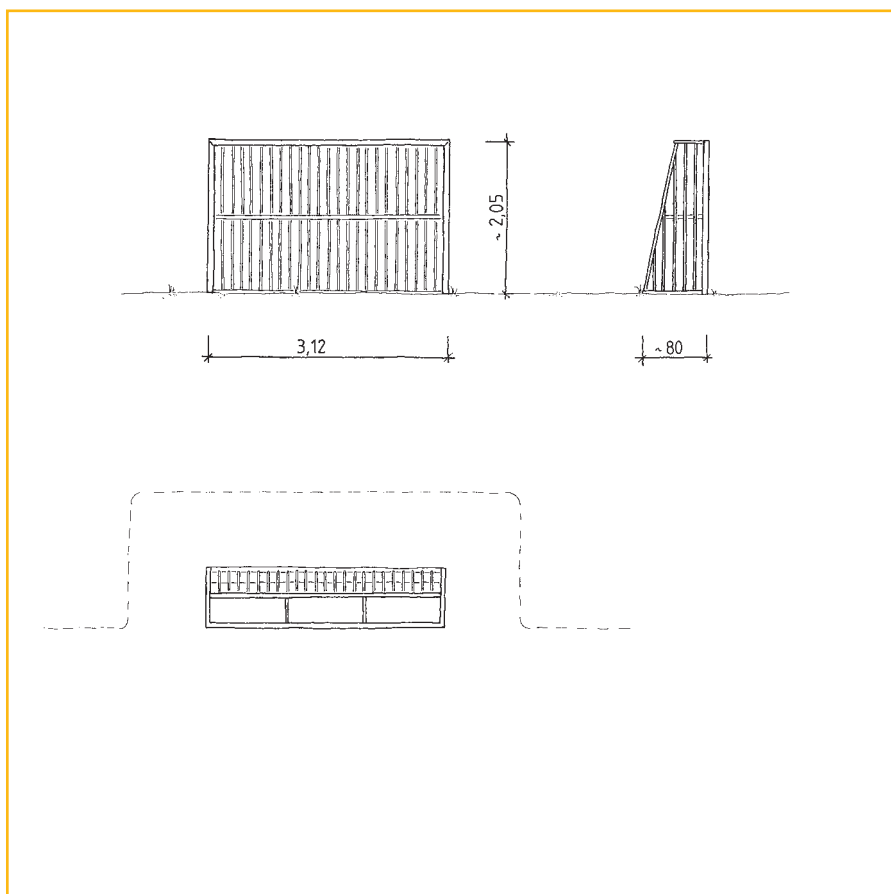

Multi-activités

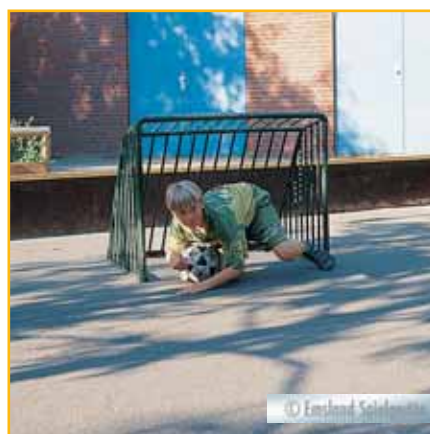

Référence 131622



Multi-activités

Référence 131622/1V, VL

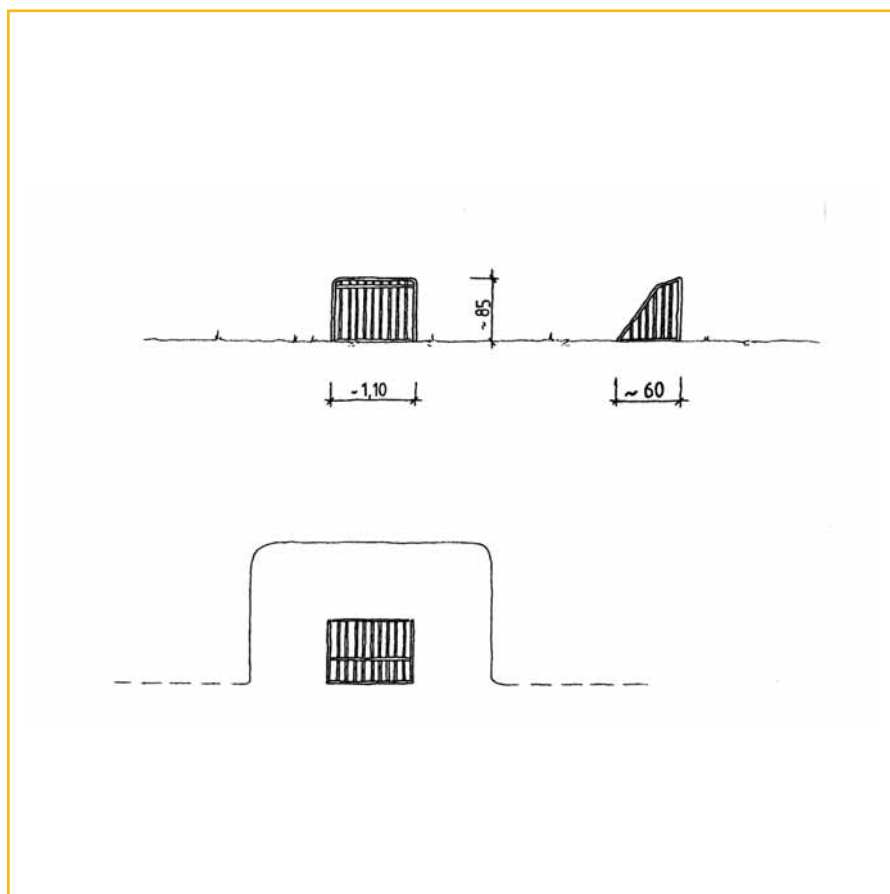

Multi-activités



Référence 131700V

Référence 131700VL

Référence 131800R



Multi-activités



Référence 131900R



Multi-activités



Référence 131640E



Multi-activités

Référence 131640E

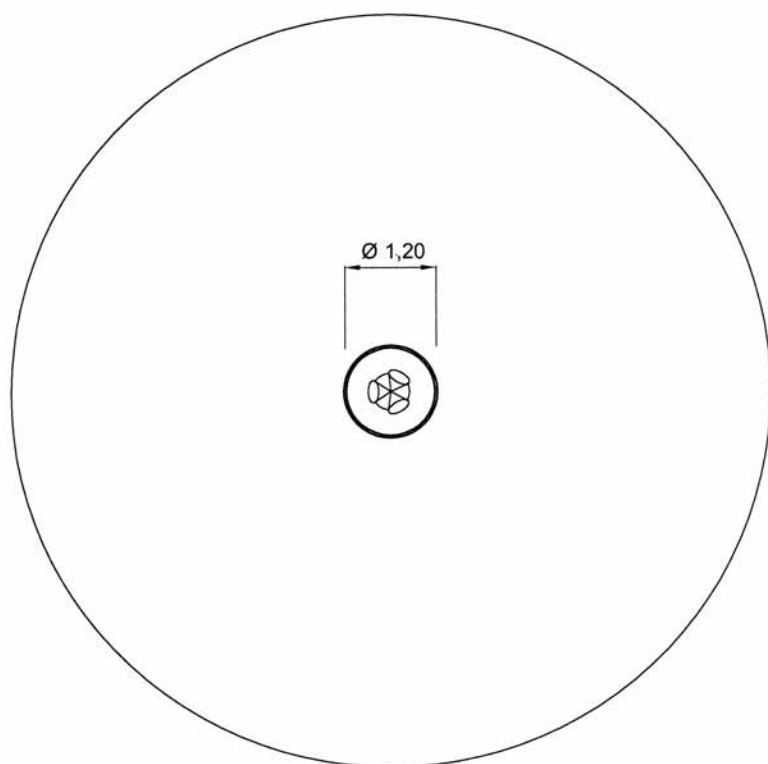
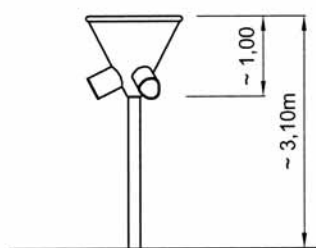

Mobilier



Mobilier



Référence type1
GAT 020401D
GAT 020401T

Référence type2
GAT 020402D
GAT 020402T

Référence type3
GAT 020403D
GAT 020403T

Référence type4
GAT 020404D
GAT 020404T



Référence type5
GAT 020405D
GAT 020405T

Référence type6
GAT 020406D
GAT 020406T

Référence type7
GAT 020407D
GAT 020407T



Référence type8
GAT 020408D
GAT 020408T

Référence type9 GAT 020409D
GAT 020409T

Référence type10
GAT 020410D
GAT 020410T

Référence type11
GAT 020411D
GAT 020411T

Référence type12
GAT 020412T
GAT 020412T

Référence type13
GAT 020413D
GAT 020413T

Référence type14

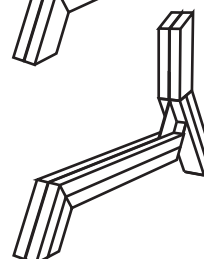
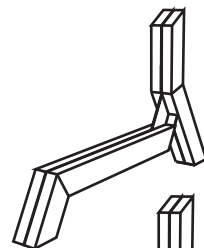
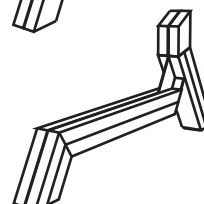
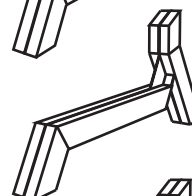
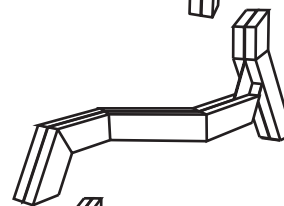
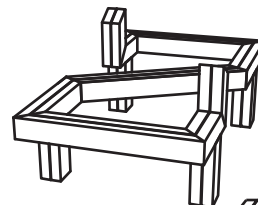
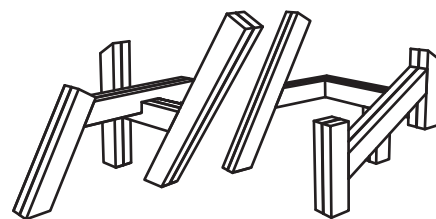

Mobilier

GAT 020414D
GAT 020414T

Référence type15
GAT 020415D
GAT 020415T

Référence type16
GAT 020416D
GAT 020416T

Référence type17
GAT 020417D
GAT 020417T

Référence type18
GAT 020418D
GAT 020418T

Référence type19
GAT 020419D
GAT 020419T

Référence type20
GAT 020420D
GAT 020420T

Référence type21
GAT 020421D
GAT 020421T

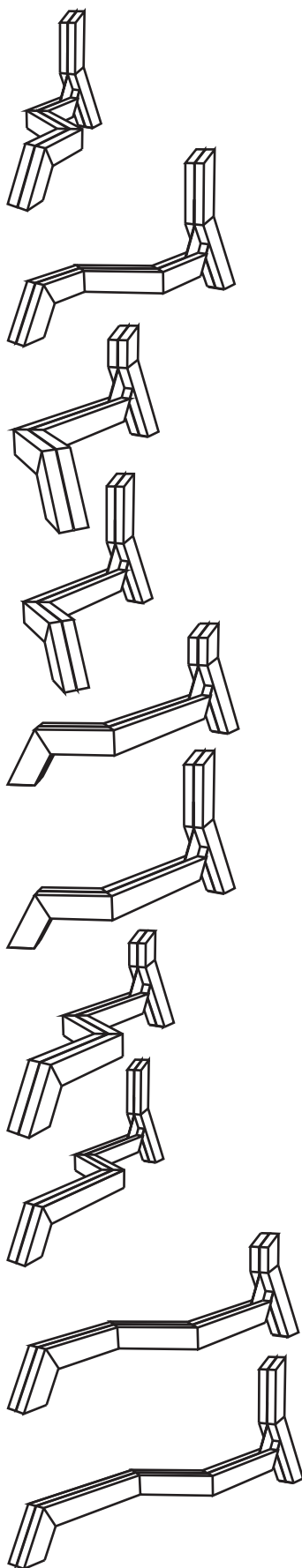

Mobilier

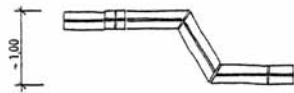
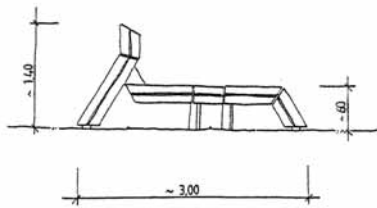

GAT 02 04 04 D/T

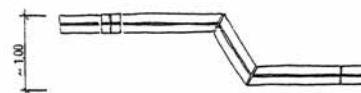
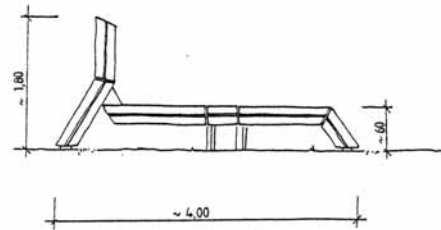

GAT 02 04 12 D/T

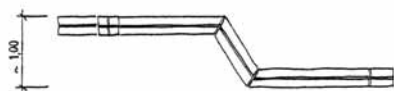
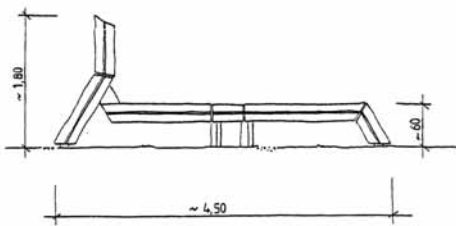

GAT 02 04 21 D/T



Référence GAT 020001

Référence GAT 020002-04

Mobilier

Référence GAT 02 0001D, R

Référence GAT 02 0002-04D, R

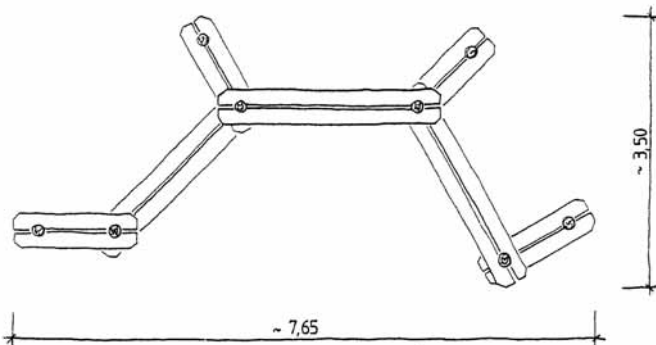
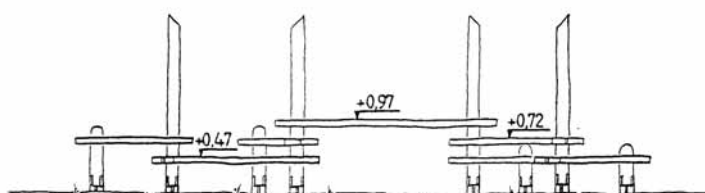

LÜMMELMÖBEL
GAT 02 0001D/R

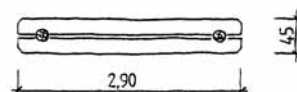

GRUNDELEMENT
GAT 02 0002 D/R

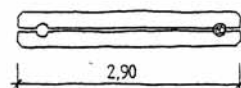

ANSCHUSSELEMENT
GAT 02 0003 D/R

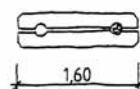

ANSCHUSSELEMENT
GAT 02 0004 D/R



Référence GAT 020100-03R

Mobilier

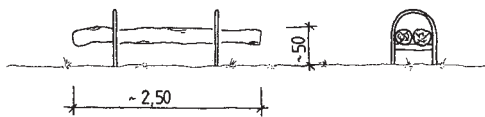

tief
GAT 02 0100.R

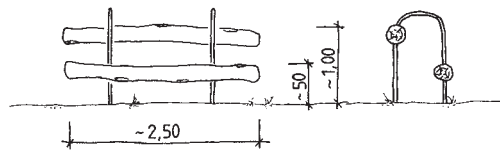

tief / hoch
GAT 02 0102.R

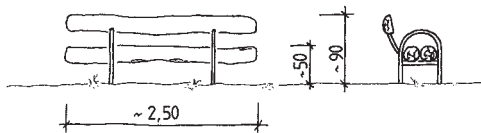

tief mit Lehne
GAT 02 0101.R

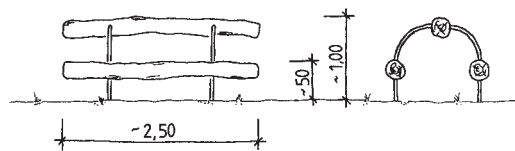

tief / hoch / tief
GAT 02 0103.R



Référence GAT 020701R



Mobilier

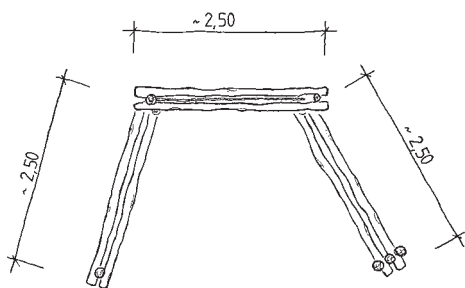
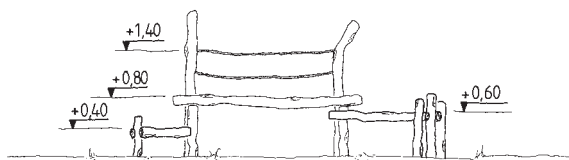

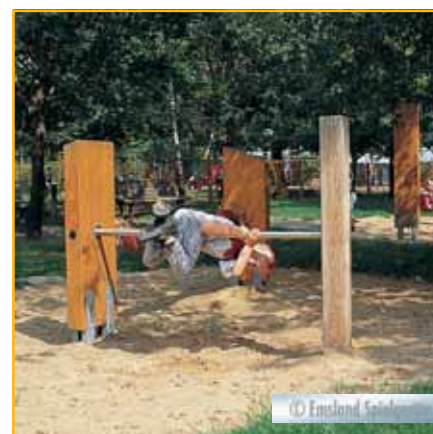

Référence GAT 021100T

Référence GAT 021200T

Mobilier

Référence GAT 021100T

Référence GAT 021200T

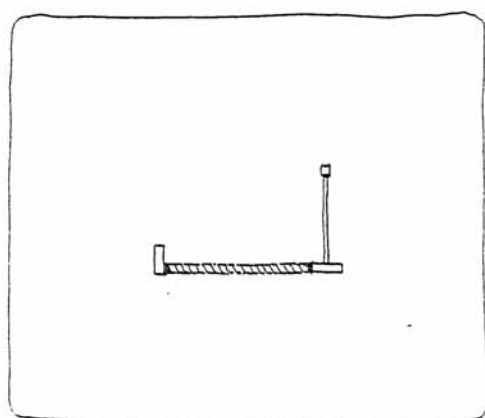
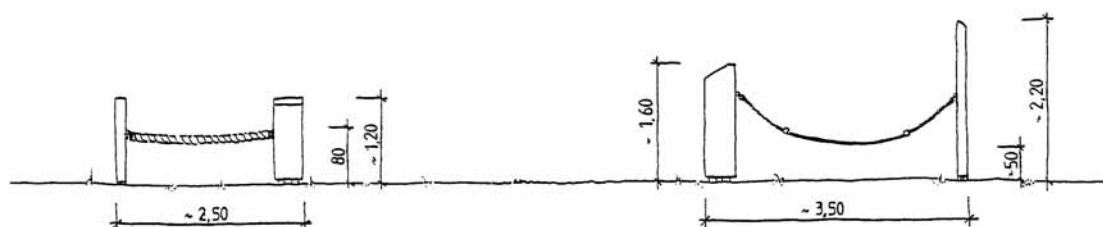

Stelen mit Tampen und Reckstange
GAT 02 1100 T

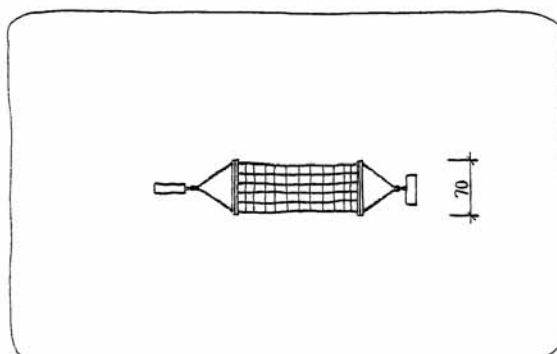

Stelen mit Hängematte
GAT 02 1200 T



Référence GAT 021500

Référence GAT 021400



Mobilier

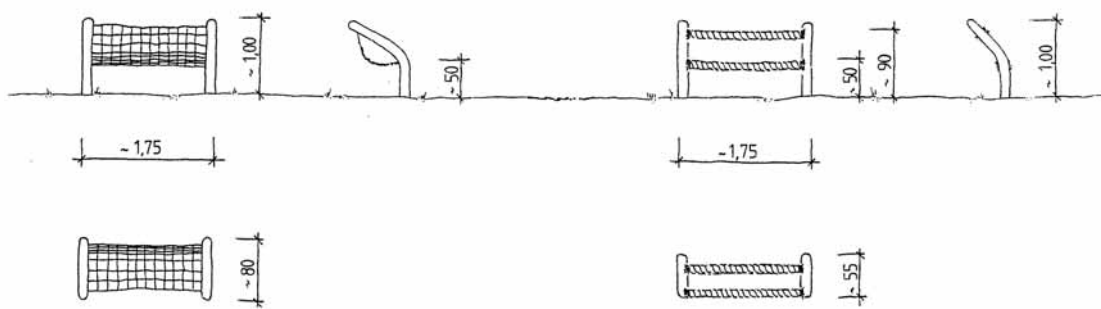

Netz - Sitz
GAT 02 1500

Kokastampen - Sitz
GAT 021400

Mobilier

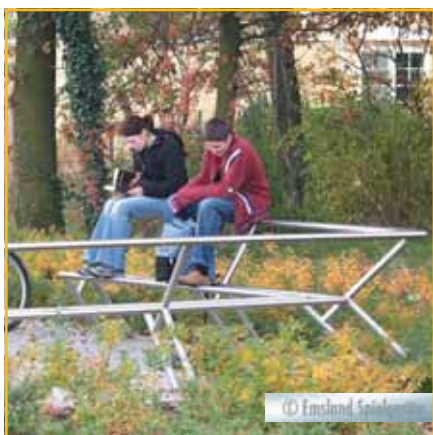

Référence 140160-61
Référence 140170-71

Mobilier

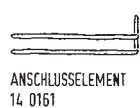
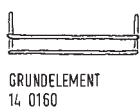
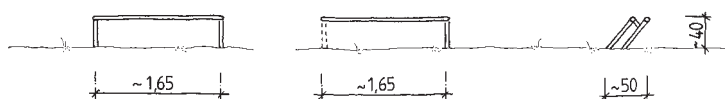

ohne Lehne

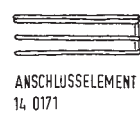
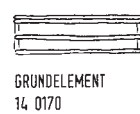
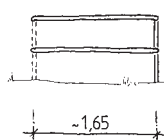
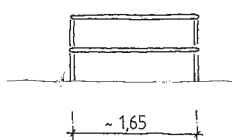

mit Lehne

Mobilier



Référence 140150-51



Mobilier

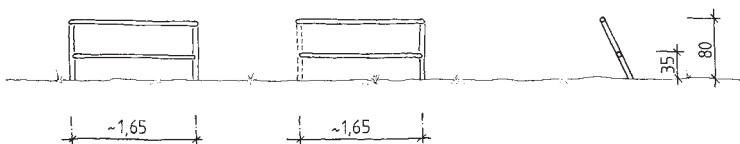

GRUNDELEMENT
14 0150



ANSCHLUSSELEMENT
14 0151



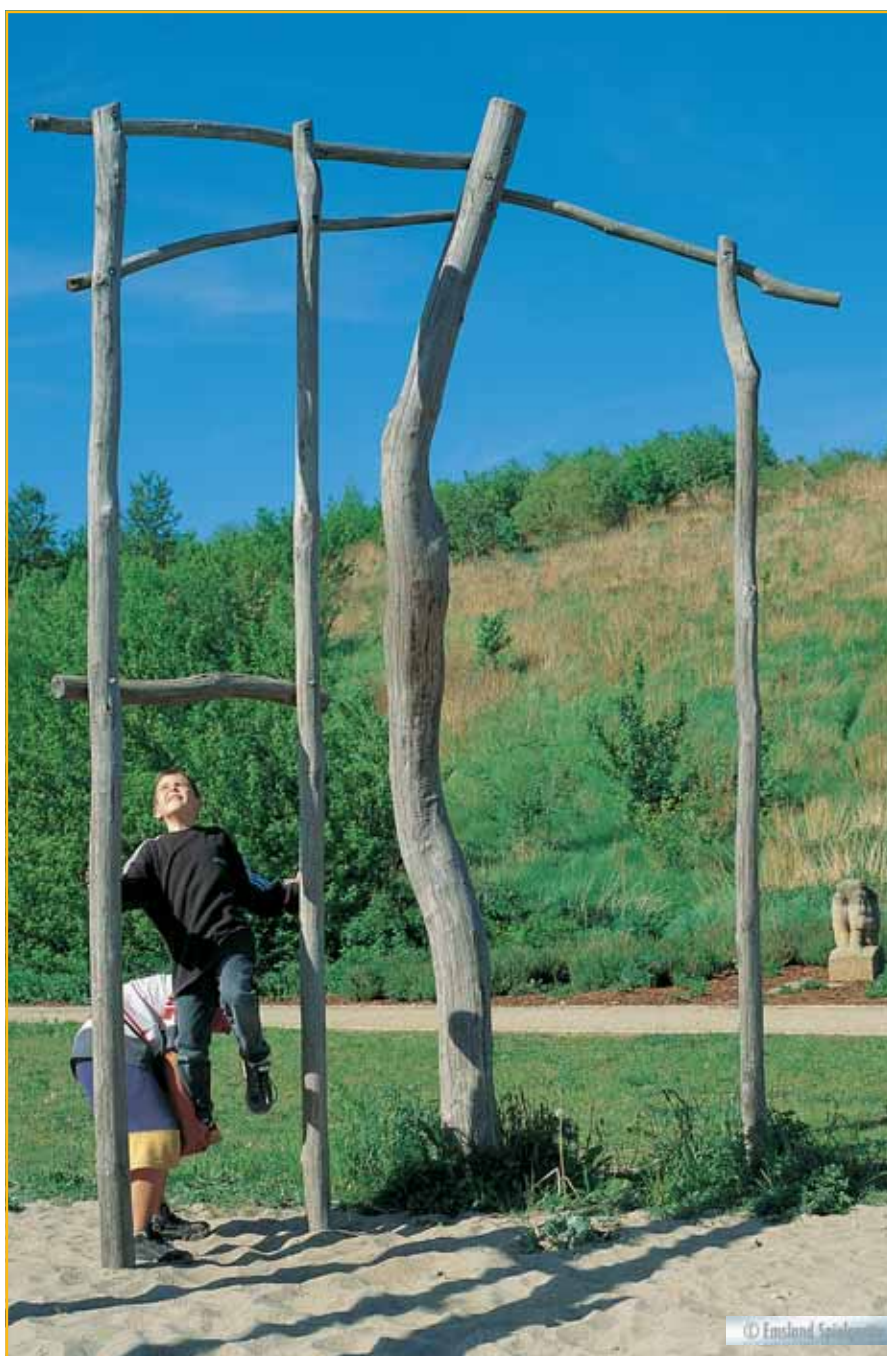
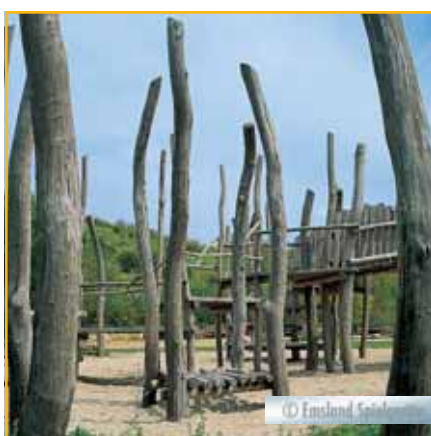

Référence GAT 021601R

Référence GAT 021602R

Référence GAT 120400R

Mobilier

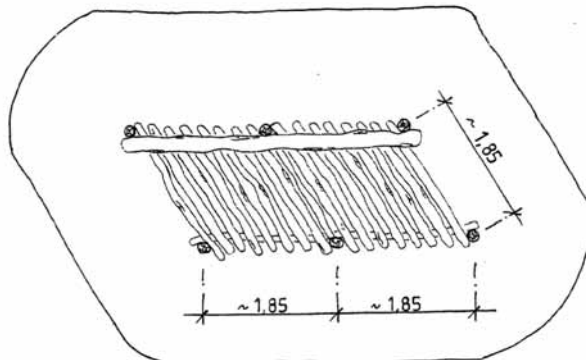
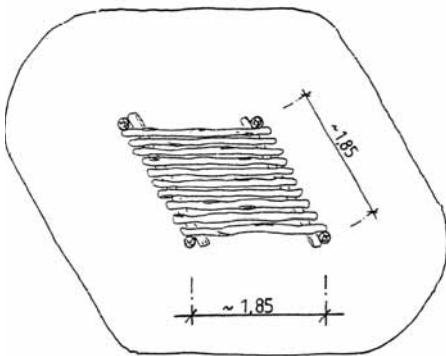
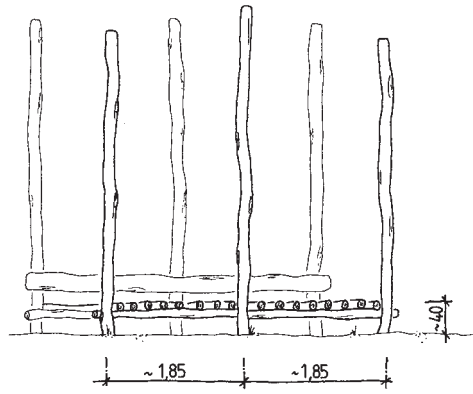
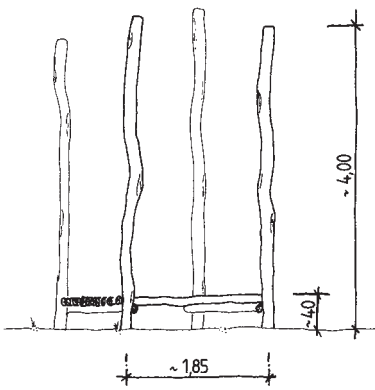

Stangensitz
GAT 02 1601 R

Stangensofa
GAT 02 1602 R

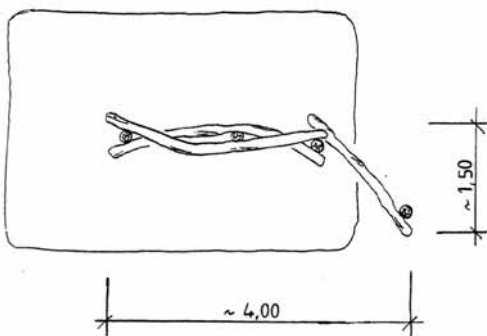

Landschaftszeichen Reck
GAT 12 0400 R

Mobilier



Mobilier sur mesure



Mobilier



Mobilier



Mobilier





Référence 142690

Référence 142701

Référence 140685

Mobilier

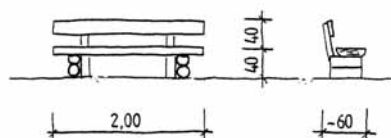

ROBINSONBANK MIT LEHNE
14 2690 D/R

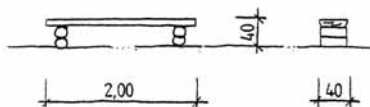

ROBINSONBANK OHNE LEHNE
14 2701 D/R

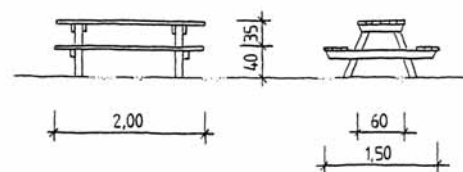

PICKNICK-TISCH
14 0685 D/R



Mobilier



Mobilier

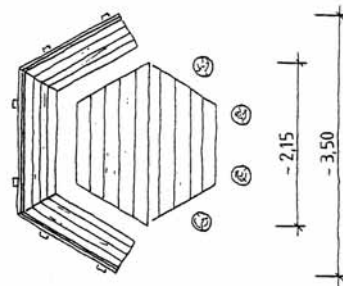
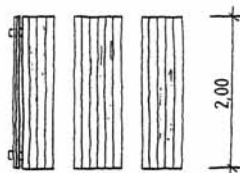
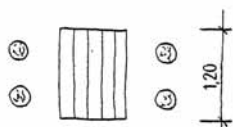
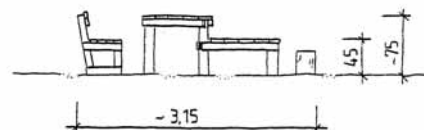
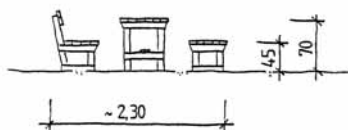
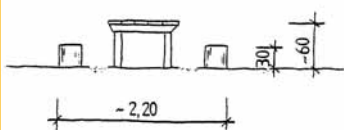

SPIELTISCH MIT HOCKERN
11 2706 D/R

SPIELTISCH MIT BÄNKEN
11 2692 D/R

FAMILIEN-SITZGRUPPE
11 2708 D/R

Points de rencontre

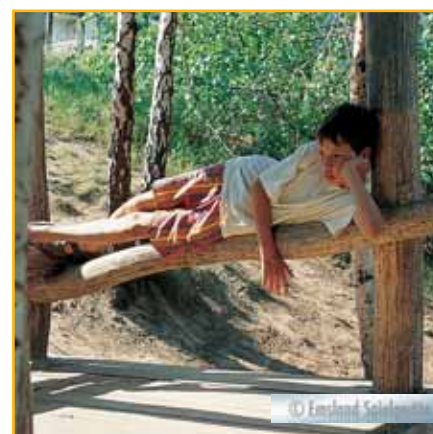
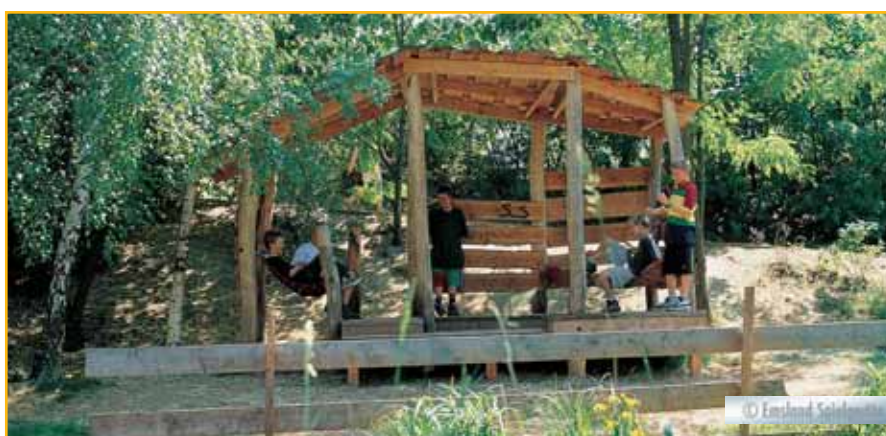

Référence GAT 010001R

Référence GAT 010002R



Points de rencontre

Référence GAT 010001R

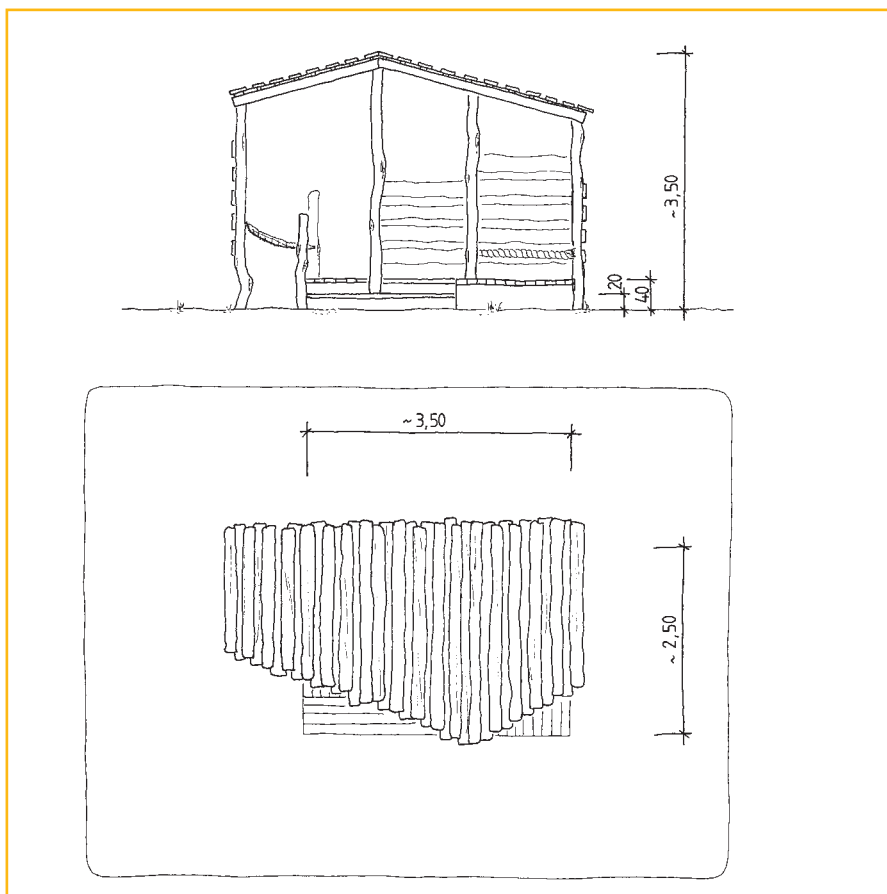

Référence GAT 010002R

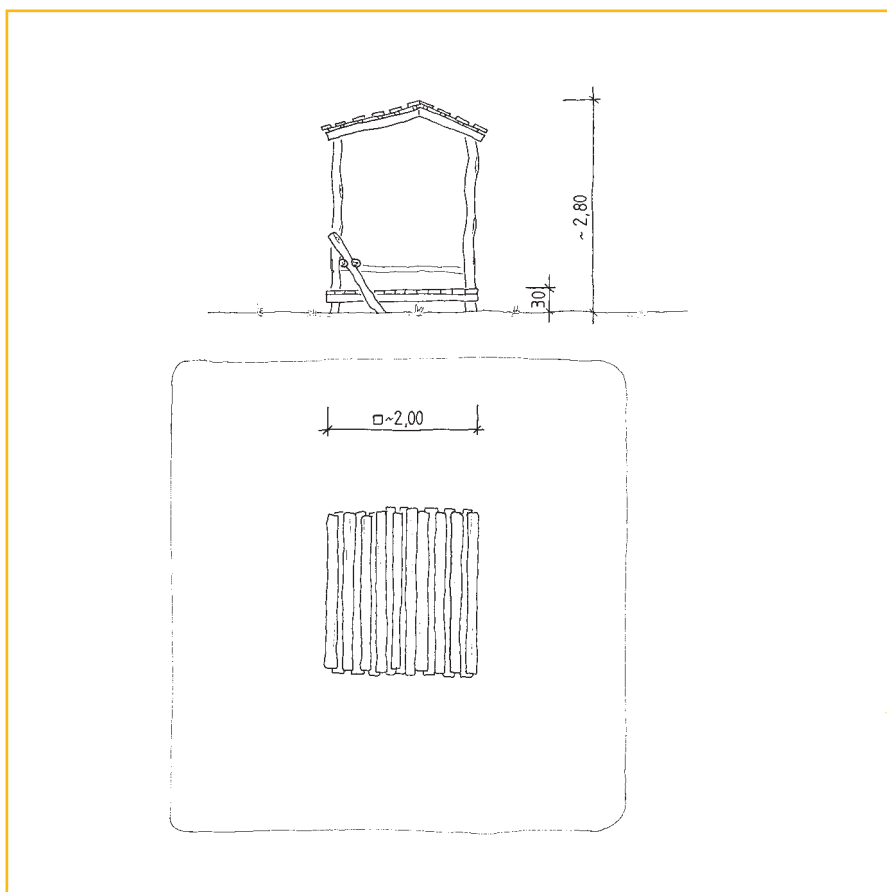

Points de rencontre



Référence 161005 - 90D



Points de rencontre

Référence 161005 - 90D

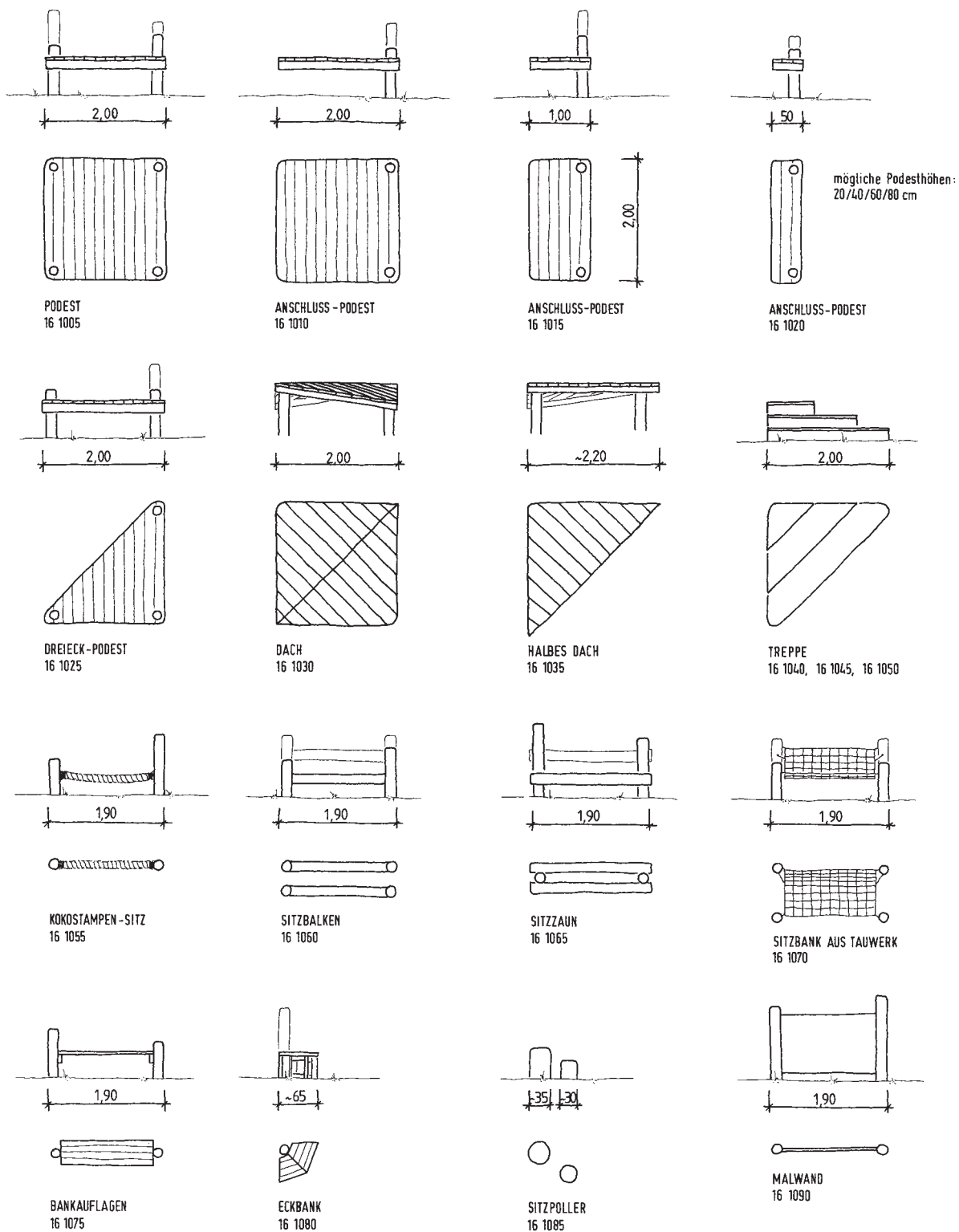

Points de rencontre



Référence GAT 010800R



Points de rencontre

Référence GAT 010800R

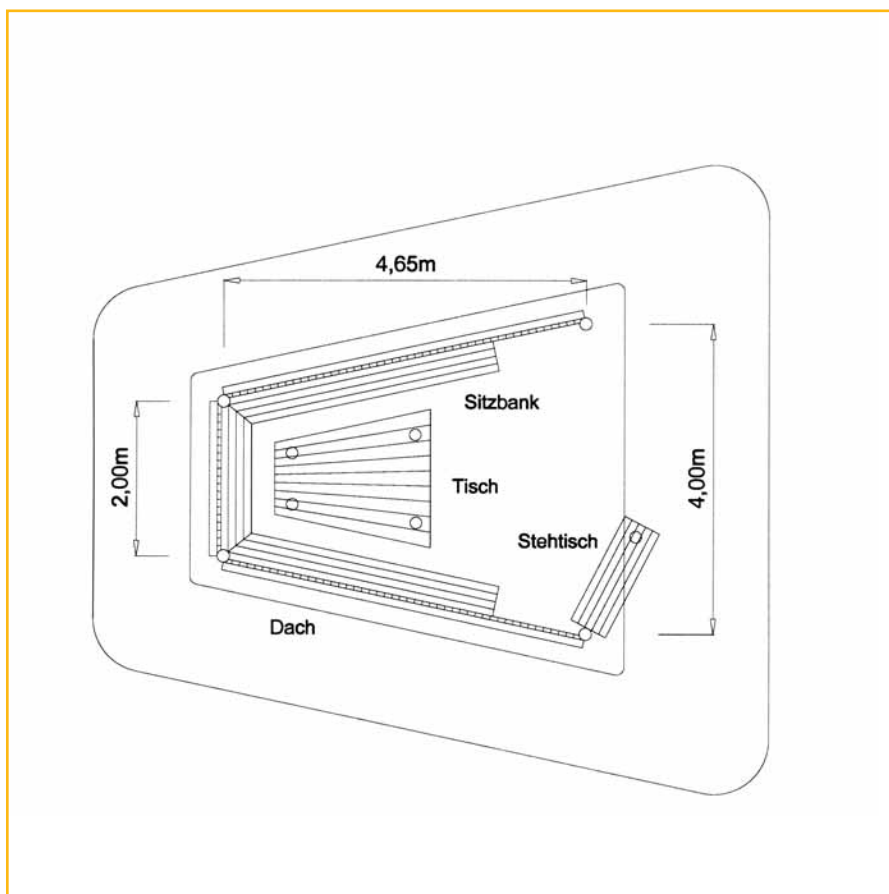

Points de rencontre



Points de rencontre

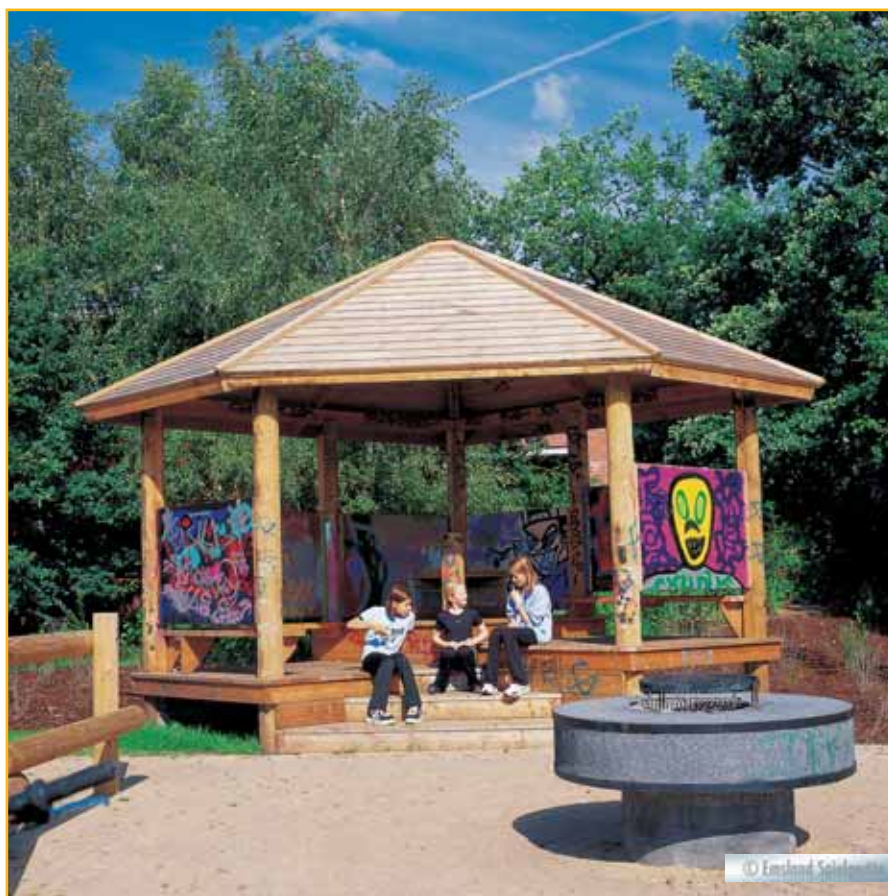

Points de rencontre



Référence GAT 060300R



Points de rencontre

Référence GAT 060300R

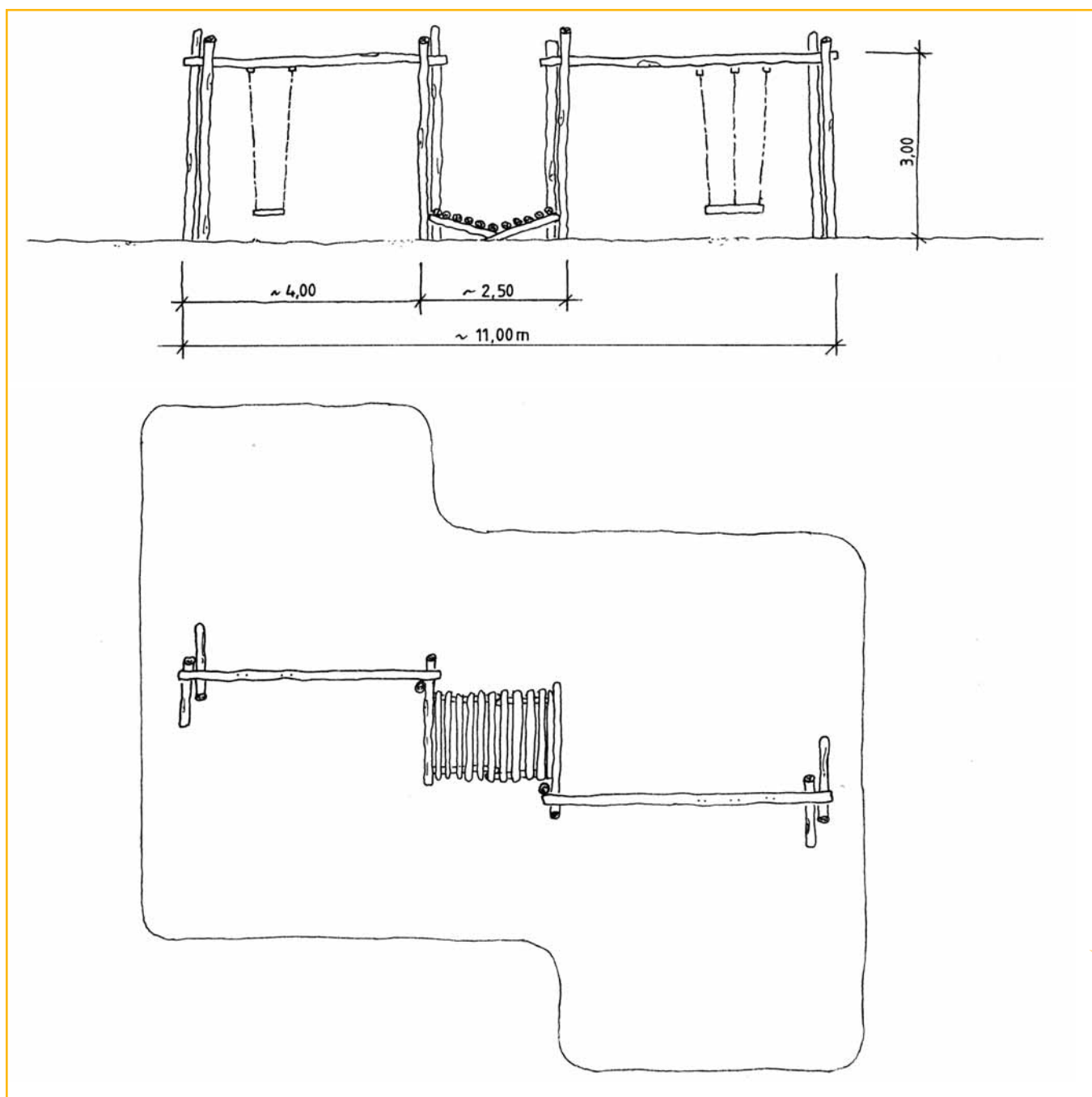

Edelstahl und Kleinkindergeräte (U3)

Kinderland
Emsland Spielgeräte

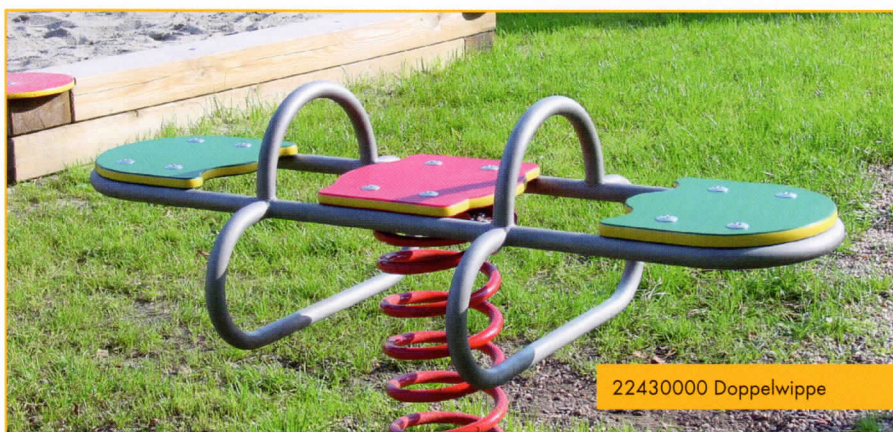

22430000 Doppelwippe



22405000 Motorrad



22386KPE Jumbo mit Rückenlehne



22304KPE Frog mit Rückenlehne



22430KPE Doppelwippe mit Rückenlehne



22405KPE Motorrad mit Rückenlehne



223990PE Delfin

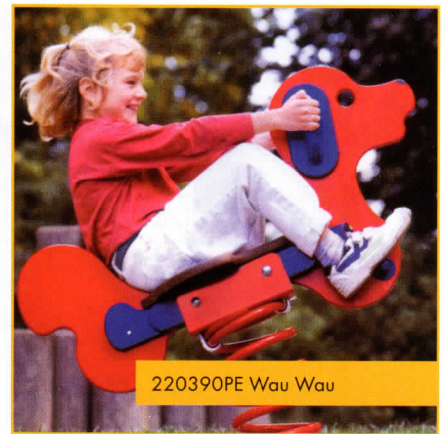

220390PE Wau Wau

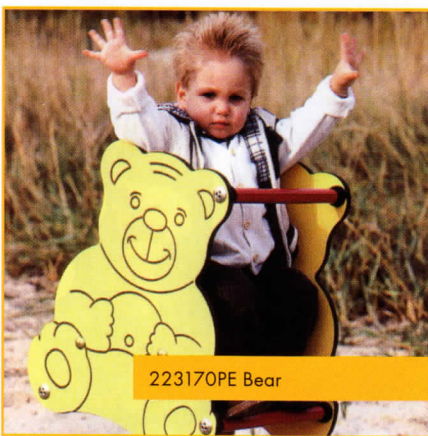

223170PE Bear



223290PE Dog



220380PE Quaki



220680PE Reifenkreisel



223780PE Giraffe



223700PE Katzenwippe

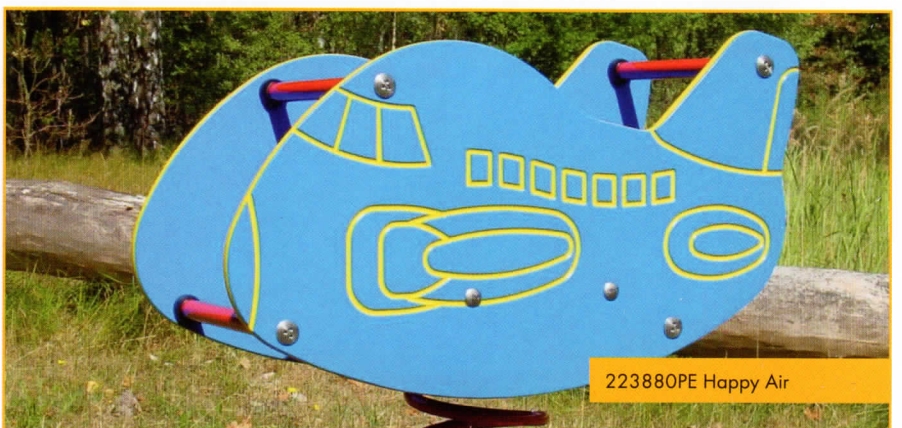

223880PE Happy Air

Kunststoff



220710PE Grashopper



220550PE Hundewipper



220410PE Feuerstuhl



220630PE Motorrad mit Beiwagen



220620PE Fliegende Kiste



220760PE Kreuzwippe



223920PE BigDino



224060PE Polizei -Auto



220510 PE Pandabär

Holz



Spielhäuser und -autos

Kinderland
Emsland Spielgeräte



229040PE Trulli - Rathaus



225050PE Schlepper mit Balanciertampen



220800PE Etagenhaus



225060PE Schlepper mit Rutsche

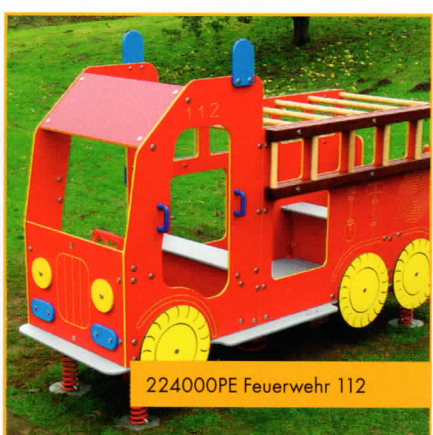

224000PE Feuerwehr 112



223850PE Jeep off Road



223480PE Kindergartenhaus



220900PE Schaukellok



225011PE Klettertreff



220460 PE Dumbo - Rutsche



228030PE Kindergartentisch





Kleine Kinder





0 1 2 3 4 5 6

sehen
hören
schmecken
greifen
fühlen
tasten

ordnen von Dingen
steife Wege erkabbeln
selbständig gehen
grobmotorisch balancieren (teilweise krabbelnd auf eckigem, nicht zu wackelig, ebenerdig)

Farben bewusst wahrnehmen
nachspielen (Sandspiel mit Beförderung/ realistisches Spielmaterial wird aktiv erlernt)
Spielschiff/Ritterburg)
schaukeln mit Begleitung (Anschubser/danebenliegend in der Vogelnestschaukel)
klettern auf kleine Podeste, Treppen aufrecht
Ball in Richtung bewegen / werfen

0-2 Jährige

sensomotorisches Spiel (Krach machen)
nachahmen (erste Spielhüttenspiele/telefonieren)

Explorationsspiel
Materialien erführen
Hölzer/Steine/Metallketten)

Funktionslust
schräge Flächen erkabbeln
Zerrspiegel, Wind/Schattenspiel beobachten

Bewegungsfreude
Hindernisse überwinden
mit Ball laufen

Freude am Effekt (Regelmäßigkeit)
unsicher gehen

von Aktionen)
Zerlegen/Austräumen von Gegenständen
Treppen erklimmen

Erfahrung der Selbstwirksamkeit
erste seichte Rutschserlebnisse
Schiffe/Ähren/Schiffchen

(„ich“kann Dinge verändern“)

schneller laufen
„zwei Bein hüpfen“

drehen in Gemeinschaft (gemeinsam auf dem Karussell)
selbständiges „Bauchschaukeln“
einfache Labyrinth nachlaufen (2D)
selbständig rutschen

Rollenspiel
Laufrad fahren (freie Flächen bespielen)
Bobbycar fahren

2-4 Jährige

sensomotorisches Spiel

Symbolspiel

Konstruktionsspiel

Explorationsspiel

Objektpermanenz

4-6 Jährige

sensomotorisches Spiel

Regelspiel

Symbolspiel

Konstruktionsspiel

Rollenspiel

Explorationsspiel
nicht den Boden berühren spielen (balancieren (wackelig, drehbar, nicht ebenerdig))
bewusst den Körper einsetzen (Schwung/Kick/Schrittsteg, Spielbagger, Wippelmente)
selbständiges Schaukeln

soziales Spiel (Metakommunikation)
Höhen erklettern (Leite)

perspektivwechsel
Boje bauen (Hütten mit Anforderungscharakter)
selbständiges Karussell fahren
selbständig Wippen

3D-Labyrinth bespielen

zeitlich ausgedehnter / inhaltlich komplexer

Inliner fahren

Reflektieren

Vorschulfähigkeiten (Mengen erfassen/ abstrahieren)

Multiplizität funktionierte: Seilbahn
Selbstbehauptung

hängeln

Stangen erklettern

Pfeifallrutschen

Ball bewusst in Richtung werfen / fangen / schießen

zusammengestellt und gestaltet von Dipl.-Des. Birthe Mlyczak

Spielfähigkeiten in der KITA

0

sehen
hören
schmecken
greifen
fühlen
tasten

1

rollen
robben
Laute geben
mich artikulieren

2

ordnen von Dingen
steile Wege erkabbeln
selbständig gehen
grobmotorisch **balancieren** (teilweise krabbelnd auf eckigem, nicht zu wackelig, ebenerdig)
Farben bewusst wahrnehmen
nachspielen (**Sandspiel mit Beförderung/ realistisches Spielmaterial** wird positiv erkannt (Spielschiff/Ritterburg))

3

schaukeln mit Begleitung (Anschubser/danebenliegend in der Vogelnestschaukel)
klettern auf kleine Podeste, Treppen aufrecht
Ball in Richtung bewegen / werfen

4

schneller laufen
„zwei Bein hüpfen“
drehen in Gemeinschaft (**gemeinsam auf dem Karussell**)
selbständiges „**Bauchschaukeln**“
einfache **Labyrinth** nachlaufen (2D)
selbständig rutschen

5

Laufрад fahren (freie Flächen bespielen)
Bobbycar fahren
erklettern von höheren Spielpodesten

6

Regeln einhalten
rollern
nicht den Boden berühren spielen (**balancieren (wackelig, drehbar, nicht ebenerdig)**)
bewusst den Körper einsetzen für Schwung/Kraft (**Gurtsteg, Spielbagger, Wippelemente**)
selbständiges **Schaukeln**
Höhen **erklettern (Leitern/Bäume/Netze/Wände)**
Bude bauen (**Hütten mit Aufforderungscharakter**)
selbständiges **Karussell fahren**
selbständig **Wippen**
3D-Labyrinth bespielen

unsicher gehen
Zerlegen/Ausräumen von Gegenständen
Treppen erklimmen
erste seichte Rutscherlebnisse
Seile zum Hochziehen

radfahren
Inliner fahren
„ein Bein hüpfen“
Vorschulfähigkeiten (Mengen erfassen/ abstrahieren)
Tellersitz funktioniert: Seilbahn

hangeln
Stangen erklettern
Freifallrutschen
Ball bewusst in Richtung **werfen / fangen / schießen**

Spielfähigkeiten in der KITA

zusammengestellt und gestaltet von Dipl.-Des. Birthe Mlynzak







Vorwort

Kleine Kinder spielen...

Zwischen 0 und 6 Jahren eröffnet sich Kindern die Welt. Alle naturgegebenen, sozialen, physischen und sprachlichen Phänomene werden erlebt, ausprobiert und getestet. Kurz gesagt: Es wird gespielt!

Am Anfang bedeutet Spielen einfach nur das **Erleben** und die Freude am Effekt, das Erfahren der Dinge. Das Spielen wird mit der Zeit aber immer komplexer und bietet mehr Möglichkeiten, sich und die Umwelt intensiv zu erkunden.

Um dieses Spielerleben möglich zu machen, braucht es Orte, die anregen, die Möglichkeiten bieten und die Lust auf mehr Spielen machen. Orte, die nicht gefährlich sind und trotzdem Herausforderungen bieten. Orte, die neugierig machen und unterstützen.

Hier sollten Möglichkeiten zum „Hochhinauskommen“ gegeben sein, genauso wie zum versteckt Zurückziehen. Perspektivwechsel sollten geboten werden, sowie Treffpunkte, die zu Ritualen einladen. Mit den Händen kleine klingende Dinge erfahren ist ebenso wichtig wie mit dem ganzen Körper fühlen zu können oder in Schwingung zu geraten.

Diese Orte können Sie gemeinsam mit uns planen und **gestalten**. Hierzu bieten wir Ihnen Spielgeräte mit hohem Qualitätsstandard, aber vor allem hohen Spielwert.

Uns liegt es besonders am Herzen, auf Ihre Vorstellungen und die Wünsche der Kinder einzugehen.

Teilen Sie uns diese mit! Lassen Sie uns gemeinsam Spielräume **entwickeln**, mit denen sich kleine Kinder groß und wohl fühlen.



Die selbständige Diplom-Designerin für Spiel und Lernen, Birthe Mlynczak aus Halle/Saale, hat diese Broschüre inhaltlich und textlich exklusiv für die Firma Kinderland Emsland Spielgeräte erarbeitet.

Häuser und Zäune mit Spielwert

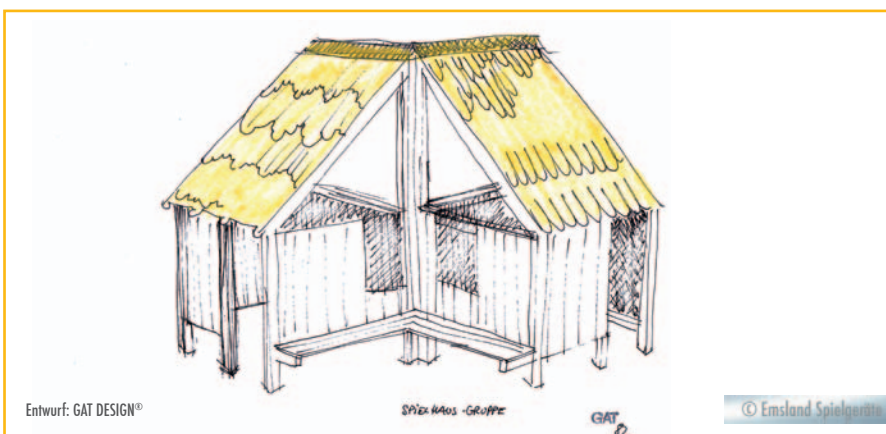
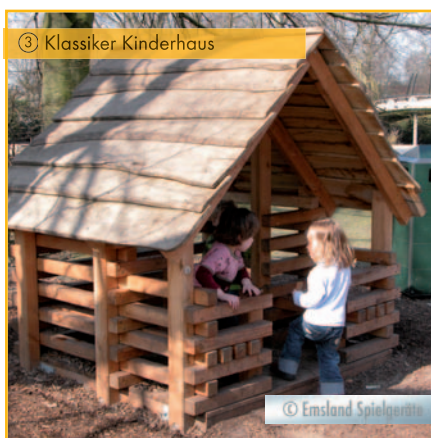

Tür auf, Tür zu, Guckguck!

Ein Spiel, das man ab einem gewissen Alter über Stunden mit Begeisterung spielen kann. Spielhäuser bieten diese Türen oder Fenster, mit denen kleine Kinder die Welt der Großen nachspielen oder einfach mal ausschließen können.

Häuser stellen Rückzugsräume dar, die zu Orten des Träumens werden, aber auch zum Treffen einladen können.



⑥ Minikiosk



© Emsland Spielgeräte

⑦ Musterhäuschen



© Emsland Spielgeräte

⑧ Märchenhütte



© Emsland Spielgeräte

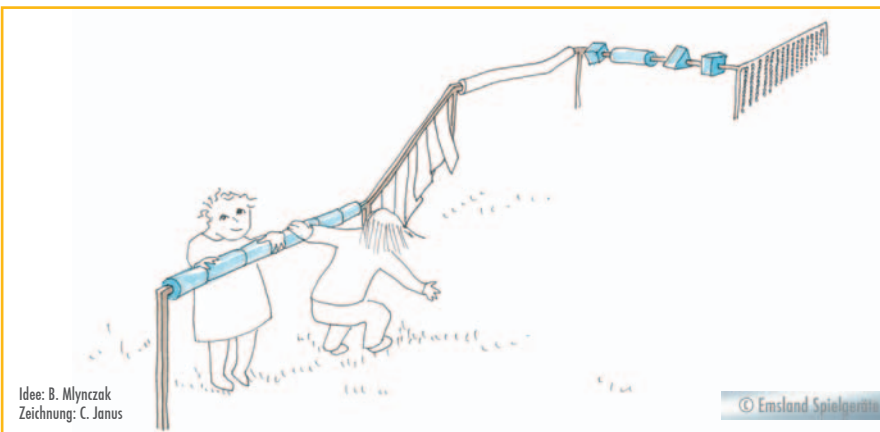

Idee: B. Mlynczak
Zeichnung: C. Janus

© Emsland Spielgeräte

Einfach entlanghängeln, ein Schritt nach dem nächsten, den Raum langsam erfahren. Zäune strukturieren den Raum.

Zwischen dem zweiten und dritten Lebensjahr wird eine unbedingte Ordnung als etwas Positives wahrgenommen. Sie bietet Schutz, beruhigt und erleichtert es, sich Überblick über „meinen“ Spielraum zu verschaffen. Die Großen können einen nicht stören.

Darüber hinaus sind Zäune bespielbar und bieten vielfältige Möglichkeiten im kreativen Spiel mit ihnen umzugehen.

⑨ Zusatz/Einsatzelemente

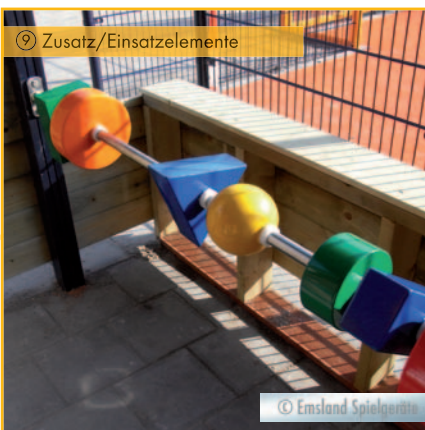

© Emsland Spielgeräte

⑩ Holzzaun

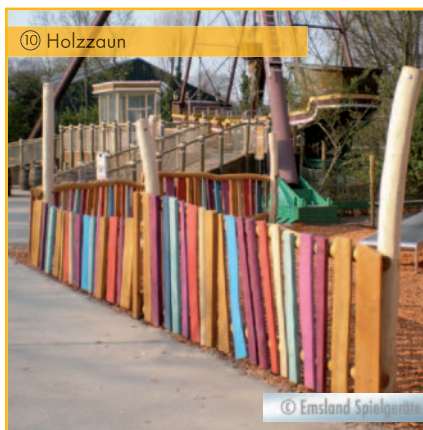

© Emsland Spielgeräte

⑪ Spielwände

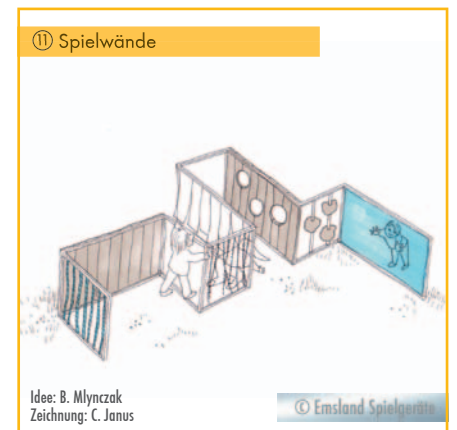

Idee: B. Mlynczak
Zeichnung: C. Janus

© Emsland Spielgeräte

Krabbelwege, Klettern, Balancieren

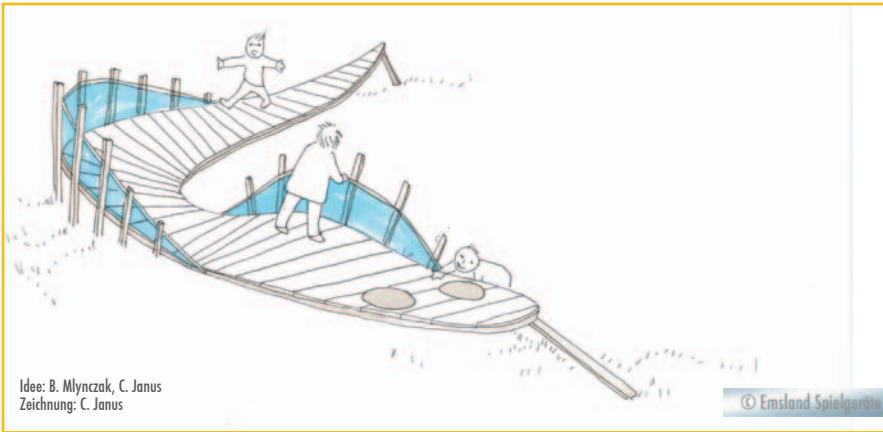

Auf allen Vieren die Welt erleben!

Auf eine kleine Anhöhe kommen, den ganzen Körper mitnehmen, es alleine schaffen.

Beim Erklettern von Balken oder niedrigen Podesten, die zu Wegen werden können, gewinnt ein Kind mehr und mehr motorische Fähigkeiten. Durch Koordination und Geschicklichkeit soll der eigene Körper bewusst in eine bestimmte Position gebracht werden. Jede Hürde wird zum „Kinderspiel“.

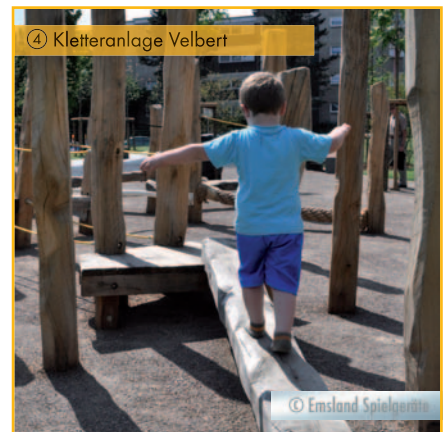



⑥ Balancieranlage Sonnenland



⑦ Kletter-/Balancierwürfel



⑧ Klettertreppe



⑨ Balanciernetz

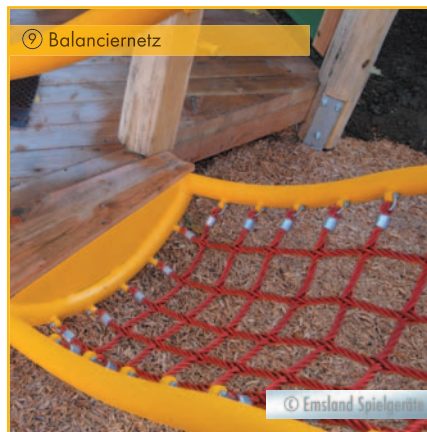

⑩ Balanciertampen

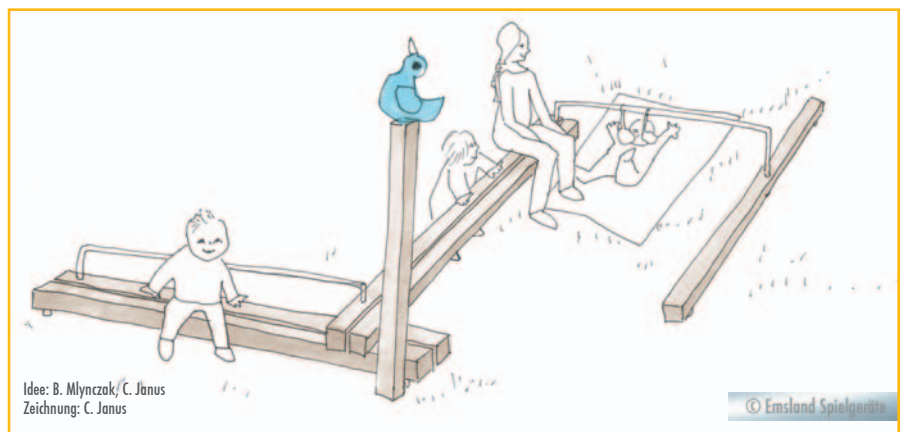

Schaukeln, Schwingen, Schweben

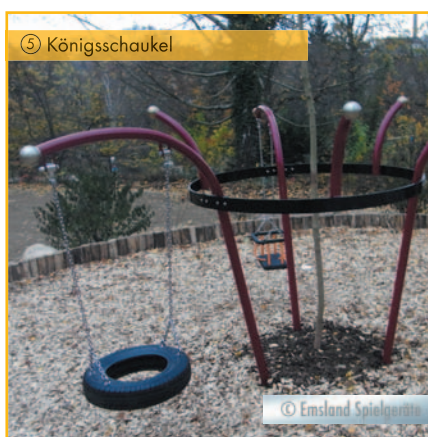
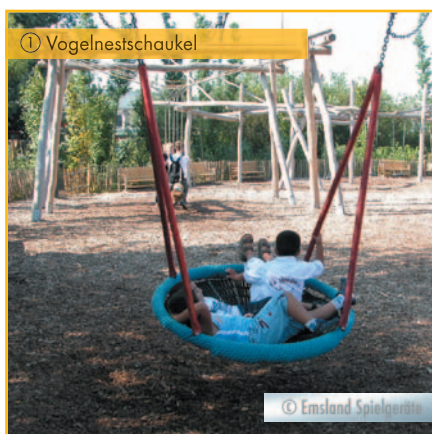

Schwingen, liegen, genießen!

Einfach nur die Bewegung genießen, eine Bewegung, die man bereits aus dem Mutterleib kennt, geschaukelt werden, Schwingungen spüren, den Körper einfach mitfliegen lassen.



⑧ Hängematte

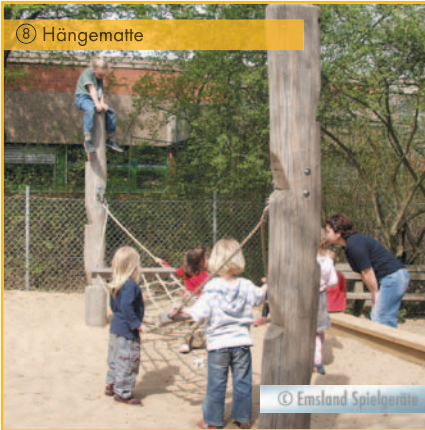

© Emsland Spielgeräte

⑨ Torschaukel



© Emsland Spielgeräte

⑩ Freischwinger



© Emsland Spielgeräte

⑪ KalottaSwing



© Emsland Spielgeräte

Dabei braucht es noch nicht mal die riesigen Höhen. Der Genuss beginnt schon mit einer leicht schwankenden Hängematte, die ich vielleicht noch mit einem Freund oder Freundin teilen kann. Hier kann ich meinen Körper spüren, ihn aus dem Gleichgewicht bringen und trotzdem wissen, dass ich ganz und gar sicher bin.

Ich hänge, liege, sitze über den Dingen und erlebe einen Perspektivwechsel, der mich groß fühlen lässt. Es ist einfach ein Genuss, sich fallen zu lassen.

⑫ Knotenpendel



© Emsland Spielgeräte

Rutschen, Drehen, Wippen



**Ich schaffe es allein
da hoch und dann....
huuuuuuu...!**

Rutschen ist ein Spiel, das immer und immer wieder wiederholt werden kann. Kontrolle über den Körper haben, sie abgeben und wiedererlangen. Das sind Glücksmomente, die das Kind selbstbewusster machen.



⑦ Stehwippe



Ein ganz ähnlicher Spielreiz findet sich in Drehelementen, egal welcher Art. Der Körper wird als Ganzes bewegt und spürt mit allen Sinnen.

Spannend ist es zu wippen: Einerseits wird mein Körper bewegt, andererseits kann ich aber auch Mitspielende bewegen. Ein Kommunikationsspiel beginnt.

⑧ Drehstern



⑨ Karussellkugel



⑩ Breitrutsche



⑪ Wellenreiter



⑫ Rutsch-Krabbelrampe



⑬ Wipptier



Sand und Wasser

① Sand- und Matschanlage

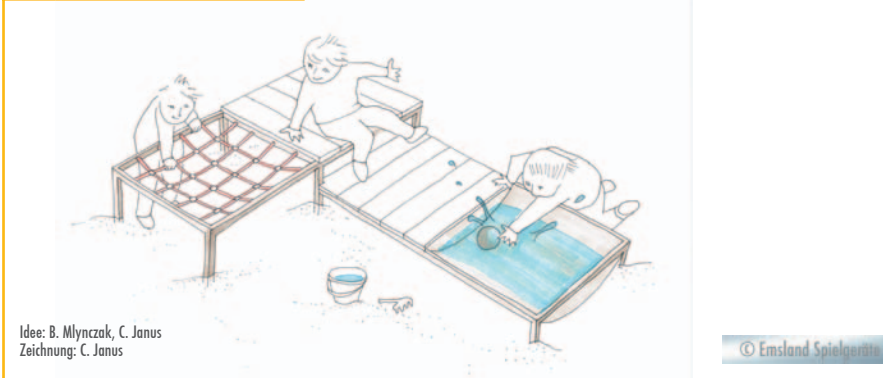

② Sandbank



Ich hole das Wasser...

...und du kannst ja den Sand schon mal in den Eimer tun.“ Der Sandkasten ist noch viel mehr als nur ein Spielort der Sinne und des Konstruktionsspiels. Er ist vor allem ein Kommunikationsort. Sand und Wasser animieren alle Kinder egal welchen Alters gleichermaßen und bieten eine Spielplattform, die zum gemeinsamen Spielen anregt. Hier geht es nicht um „Höher-Schneller-Weiter“, bei dem die „Kleinen“ oft den Kürzeren ziehen, hier geht es um Rollenspiel, um etwas, das man gemeinsam entstehen lässt.

③ Sandinsel



④ Oskar-Kiste

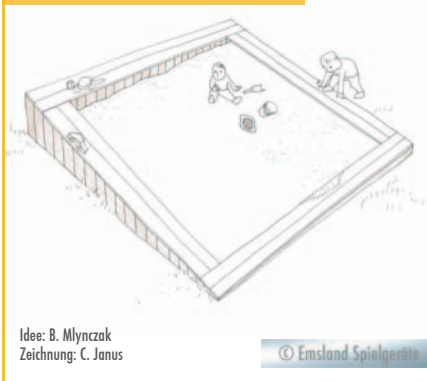

⑤ Sand-/Kletterkiste



⑥ Patentpumpe



⑦ Sandkasteneinfassung



⑧ Sand-/Matschtisch





⑨ Matschtisch



© Emsland Spielgeräte

⑩ Sandsieb



© Emsland Spielgeräte

⑪ Sandspielwerk



© Emsland Spielgeräte

⑫ Zapfstelle



© Emsland Spielgeräte

⑬ Wasserspiel



© Emsland Spielgeräte

Die Materialien Sand und Wasser sind hier unerschöpflich in ihrer Verformbar- und damit Einsetzbarkeit. Außerdem bieten sie in ihrer Materialität eine Vielfalt, die anderswo selten zu spüren wäre: kalter, schwerer Sand; warmer, rieselnder Sand; tropfender, dunkler Sand; klares kaltes Wasser im Steinloch; schnell fließendes, plätscherndes Wasser, das kaum aufzuhalten ist; warmes, riechendes Wasser mit Tieren darin und so weiter und so weiter...

Spiel mit den Sinnen

① Drehkugel



© Emsland Spielgeräte

② Schiebespielwand



© Emsland Spielgeräte

③ Windrad



© Emsland Spielgeräte

④ Lichtspielwand



© Emsland Spielgeräte

⑤ Klangspiele



© Emsland Spielgeräte

⑥ Klanghaus



© Emsland Spielgeräte

⑦ Malwand



© Emsland Spielgeräte

Kling, Klang, Klong!!

Einfach mit der Hand entlang streichen und dabei kommen Töne heraus. Und was ist das? Ein Kind, das genauso aussieht wie ich! Und wenn ich hier dran drehe..., uiui dann wird daraus ja ein Muster und ich kann es mit meiner Hand stoppen.



⑧ Drehscheibe



© Emsland Spielgeräte

⑨ Große Farfilter



© Emsland Spielgeräte

⑩ Zerrspiegel



© Emsland Spielgeräte

Das Spiel mit den Sinnen ist unendlich. Töne, Bilder, Tastwege, sie gehören zu jedem Spiel dazu. Wie schön ist es, wenn ich spüre, dass durch mein Zutun sich etwas verändert.

Das Kind begreift, nimmt sich wahr. Und wenn man begriffen hat, dass man selbst etwas manipulieren kann, kann der eigentliche Effekt sogar in den Hintergrund rücken. Alle Möglichkeiten müssen erkundet werden, eine Faszination, die viele Stunden Spiel ermöglicht.

⑪ Figuren

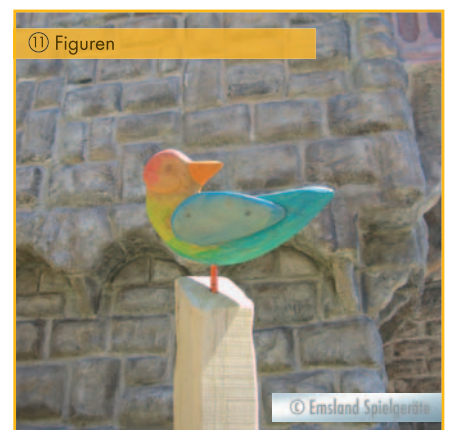

© Emsland Spielgeräte

Sitzen, Gruppieren, Überdachen

① Familiensitzgruppe



②



Zu Tisch bitte!

Zusammenkommen, einen Ort haben, der für tägliche Treffen genutzt wird, ein Ort der Rituale möglich macht. Ein gemeinsamer Ort des Sitzens sollte auch draußen definiert sein.

Die Kleinen sitzen in „ihrer“ Größe, fühlen sich ernst genommen und können solche Sitzorte auch gut zu Spielorten mutieren lassen. Es wird zu Tisch gebeten: frische Sandsuppe, mit Blättersalat und dazu Erdwasser!

③ Minisitzgruppe



④ Podest mit Sitzstein



⑤ Sitzhocker



⑥ Tier-Sitzhocker

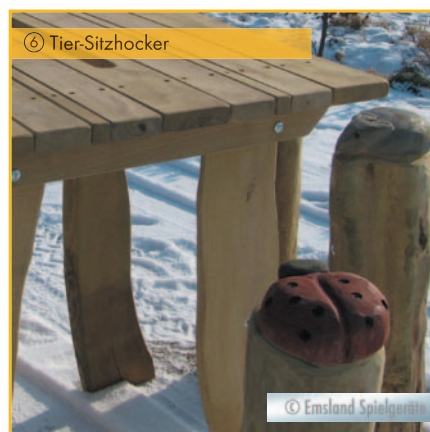



⑦ Sonnensegel



⑧ Sonnenscheibe



⑨ Sitztheater



⑩ Sonnensegel



Kinder und gerade Kleinkinder haben kaum Hautschutz. Das Spielen in der prallen Sonne sollte möglichst vermieden werden.

Aber draußen Spielen ist doch das Schönste! Das heißt, guter Sonnenschutz ist wichtig.

Gerade die Ruhespielbereiche sollten überdacht werden.

Hier sind intelligente Lösungen gefragt die fest installiert sind oder ein schnelles, unkompliziertes und eigenständiges Aufbauen von Segeln ermöglichen.

⑪ Pergola



⑫ Sonnensegel



Kinderland

Emsland Spielgeräte



Ihre Ideen?

Einen ersten Eindruck von den vielfältigen Möglichkeiten, ein Lachen in Kindergesichtern zu zaubern, haben Sie jetzt bekommen.

Einen umfassenden Überblick über weitere Spielgeräte für kleine und große Kinder bekommen Sie unter:

www.emsland-spielgeraete.de

Zahlreiche Referenzen zeigen Ihnen die vielfältigen Möglichkeiten unserer Produkte. Unsere Stärke ist unser Ideenreichtum und die umfassende Beratung.

Unsere Projekte werden Ihnen Freude bereiten. Sprechen Sie uns an!



Viele Varianten sind auch barrierefrei möglich.

Kinderland Emsland Spielgeräte
Thyssenstraße 7
49744 Geeste

Telefon 05937 97189-0
Telefax 05937 97189-90

kinderland@emsland-spielgeraete.de
www.emsland-spielgeraete.de